

Network of the Future

Cape of Good Hope

Ocean Overview Sept.2024



Directory

Information on Network of the Future	3
Key facts and figures on Cape of Good Hope ocean network	4
Service Overview Asia – Europe	5
Service Overview Asia - Middle East	18
Service Overview Asia – North America (Transpacific)	23
Service Overview Europe – North America (Transatlantic)	38
Service Overview Middle East/India - Europe	48
Service Overview Shuttles	59

Individual mainline service maps can be found in the leading trade section, and the corresponding shuttle service maps can be found at the end of the entire deck.

NETWORK OF THE FUTURE



>90%
reliability once
fully phased in



Speed via
efficiency and
optimisation



Global reach
with local service



Our Network of the Future will
deploy a fleet of 341 vessels
and a combined capacity of
3.7 million TEU.



The new network gains its
reliability and flexibility through
the optimised use of our fleets of
mainline and shuttle vessels,
combined with the global network
of transshipment hubs and inland
services.



Maersk and Hapag-Lloyd have come
together in a long-term operational
collaboration – called the **Gemini
Cooperation**.



This enhanced agility of the new
network enables us to transport your
containers on major East-West trade
lanes via optimised routes to get ahead
of potential delays and disruptions.

KEY FACTS AND FIGURES – CAPE OF GOOD HOPE NETWORK

7 East-West trade lanes



- Asia / US West Coast
- Asia / US East Coast
- Asia / Middle East
- Asia / Mediterranean
- Asia / North Europe
- Middle East – India / Europe
- Transatlantic



341

vessels in combined fleet



3.7 million

TEU combined capacity (Twenty-foot Equivalent Unit)

59

services



Mainline services

29

Shuttle services

30

13 in Europe, 12 in Asia, 4 in the Middle East, and 1 in Gulf of Mexico

transshipment hubs located like “pearls on a string”



Access to **tons of** Port pairs



Latest technology reducing cargo dwell time up to 20%

USD

3 billion+



investments in APMT Hubs for a **40% increase in capacity**

Asia to Europe - Highlights

Asia to Northern Europe:

- Upgrade Asia-Europe network = more reliable and competitive transit times across key routes.
- The network is sized for growth with flexible capacity to ensure we can consistently meet our customers' capacity requirements.
- Best-in-class from North China and Korea into main destinations in Europe.
- Multiple weekly connections from Asia to key Northern European ports including Bremerhaven, Rotterdam, and Hamburg, with expanded departure options from East and South China.
- Swift connections on our dedicated shuttles from major European gateways to Belgium, Poland, and Scandinavia, offering more competitive transit times.

Asia – Mediterranean

- Improved Asia Mediterranean network provides an overall transit time reduction of 3 days for most corridors.
- Industry leading schedule reliability and resilience are delivered by significantly reducing the number of port calls per service and associated risk of delays.
- Multiple weekly connections from Asia to key Mediterranean gateways in Spain, Italy, the Adriatic and Turkey.
- Valencia and Barcelona will experience improved transit times of 4 days on average.
- North China and South Korea will enjoy at least 1 week of improved transit times by deploying dedicated and lean shuttle services.

Asia to Europe (CoGH)

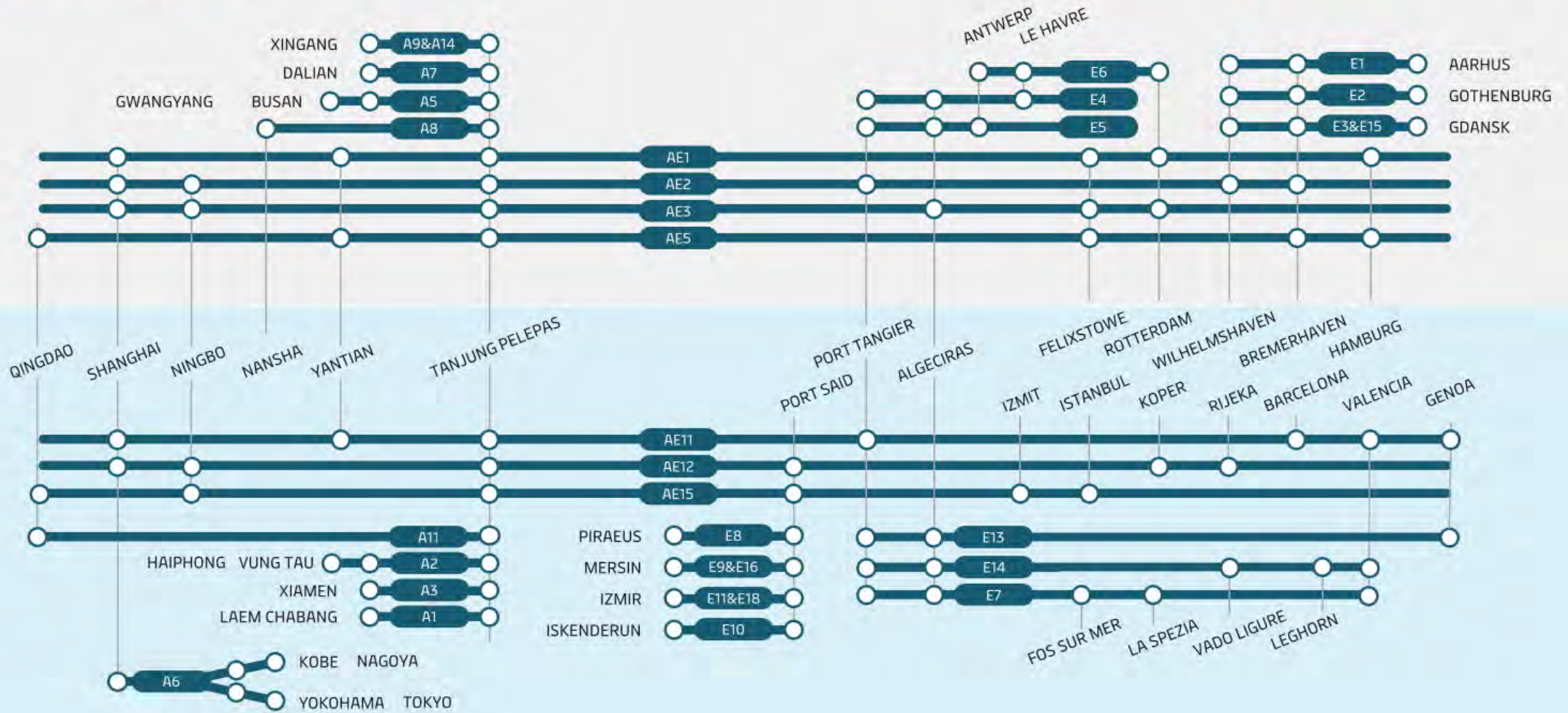

Asia – Europe

Origin/ Destination	Rotterdam	Felixstowe	Gdansk	Bremerhaven	Antwerp	Hamburg	Aarhus	Koper	Barcelona	Valencia	Istanbul	Vado Ligure
Shanghai	40	41	48	45	42	44	50	46	43	39	47	40
Ningbo	39	38	50	49	39	42	53	50	40	37	47	38
Yantian	35	37	45	41	41	39	51	44	39	35	45	36
Qingdao	40	42	51	46	44	44	54	50	45	41	51	43
Xingang	42	41	53	46	46	46	56	53	43	39	53	45
Xiamen	39	38	50	43	43	43	52	50	45	41	50	42
Busan	38	42	50	47	43	42	51	49	44	40	50	42
Vung Tau	37	35	49	42	36	42	51	42	37	33	43	35
Haiphong	41	38	53	45	38	44	55	45	40	36	46	37
Laem Chabang	36	36	47	43	36	40	52	43	38	34	44	36

**Transit time indicative only and subject to change. updated as of 10.09.2024*

Europe to Asia – Highlights

Northern Europe to Asia:

- Multiple weekly departures from key Northern European ports and flexible scheduling to East and South China, including Shanghai, Ningbo and Yantian.
- Access rapid connections to European gateways from Belgium, Poland, and Scandinavia.
- Utilize our wide-ranging connections through Bremerhaven, Hamburg, and Rotterdam for direct access to East China and Southeast Asia.
- Additionally, take advantage of efficient routes from the UK to East China and Southeast Asia, with smooth transitions via Singapore and Tanjung Pelepas.

Mediterranean – Asia

- Our improved Mediterranean to Asia network provides an overall transit time reduction of around 3 days for the majority of corridors.
- Weekly connectivity between key Mediterranean gateway ports in for example Spain, Italy, the Adriatic and Türkiye into Asia.
- Significantly improved transit time and coverage to East China.

Europe to Asia (CoGH)

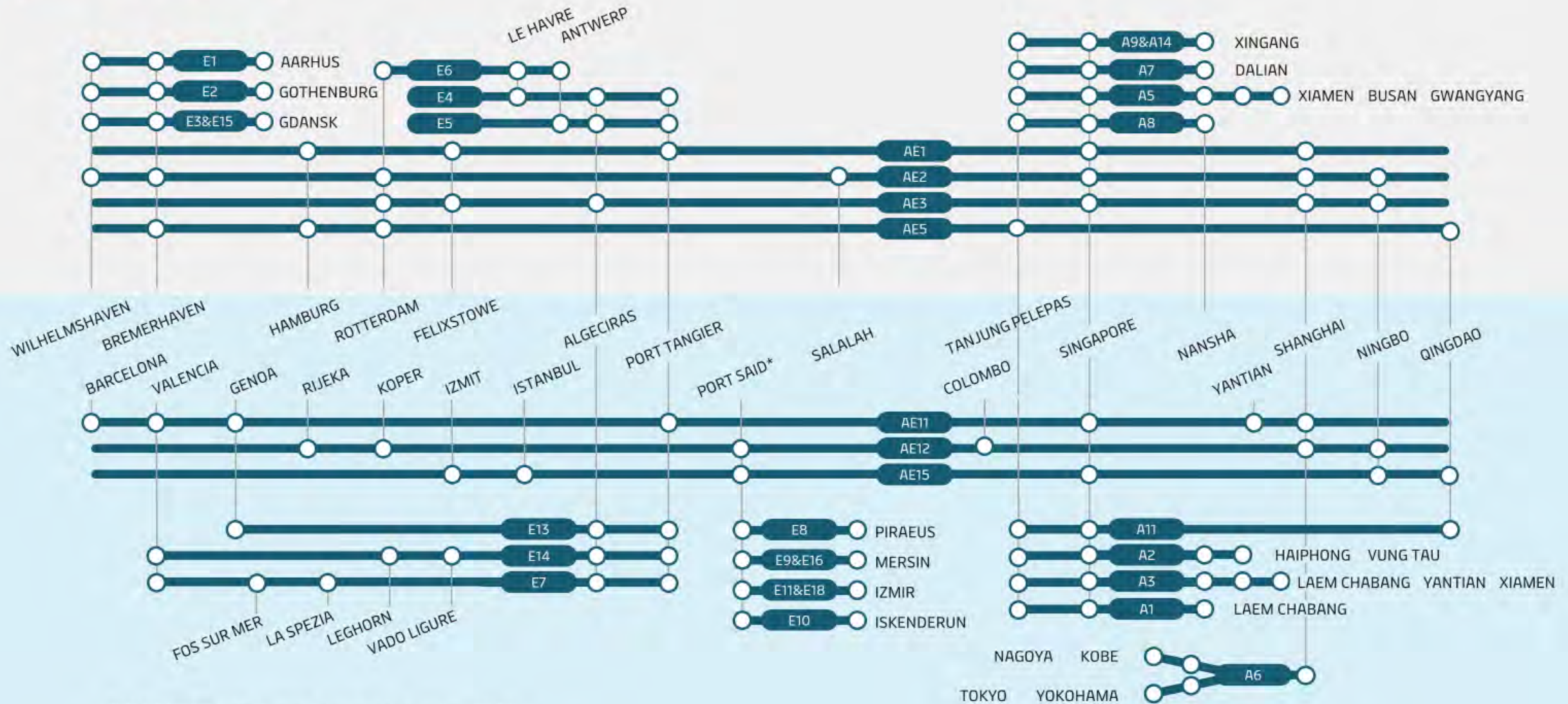

Note: *Certain Port Said EB calls will be transferred to Damietta during 2025.

Europe – Asia

Origin/ Destination	Shanghai	Ningbo	Yantian	Qingdao	Xingang	Xiamen	Vung Tau	Laem Chabang	Busan	Haiphong
Rotterdam	41	42	45	39	45	40	45	35	46	41
Felixstowe	40	47	45	47	46	44	48	38	47	40
Gdansk	58	55	56	54	60	60	61	55	64	55
Bremerhaven	49	45	47	47	52	45	50	41	49	46
Antwerp	45	49	49	48	50	49	53	43	54	44
Hamburg	44	45	48	43	50	43	48	39	48	45
Aarhus	59	56	59	53	62	56	58	50	60	55
Koper	55	50	49	58	61	56	54	52	58	57
Barcelona	43	46	47	48	47	45	52	39	51	41
Valencia	40	43	45	45	45	44	49	37	49	38
Ambarli Port Istanbul	49	47	53	48	52	47	51	43	51	47
Genoa Vado Ligure	44	47	49	50	49	48	53	41	52	42

**Transit time indicative only and subject to change. updated as of 10.09.2024*

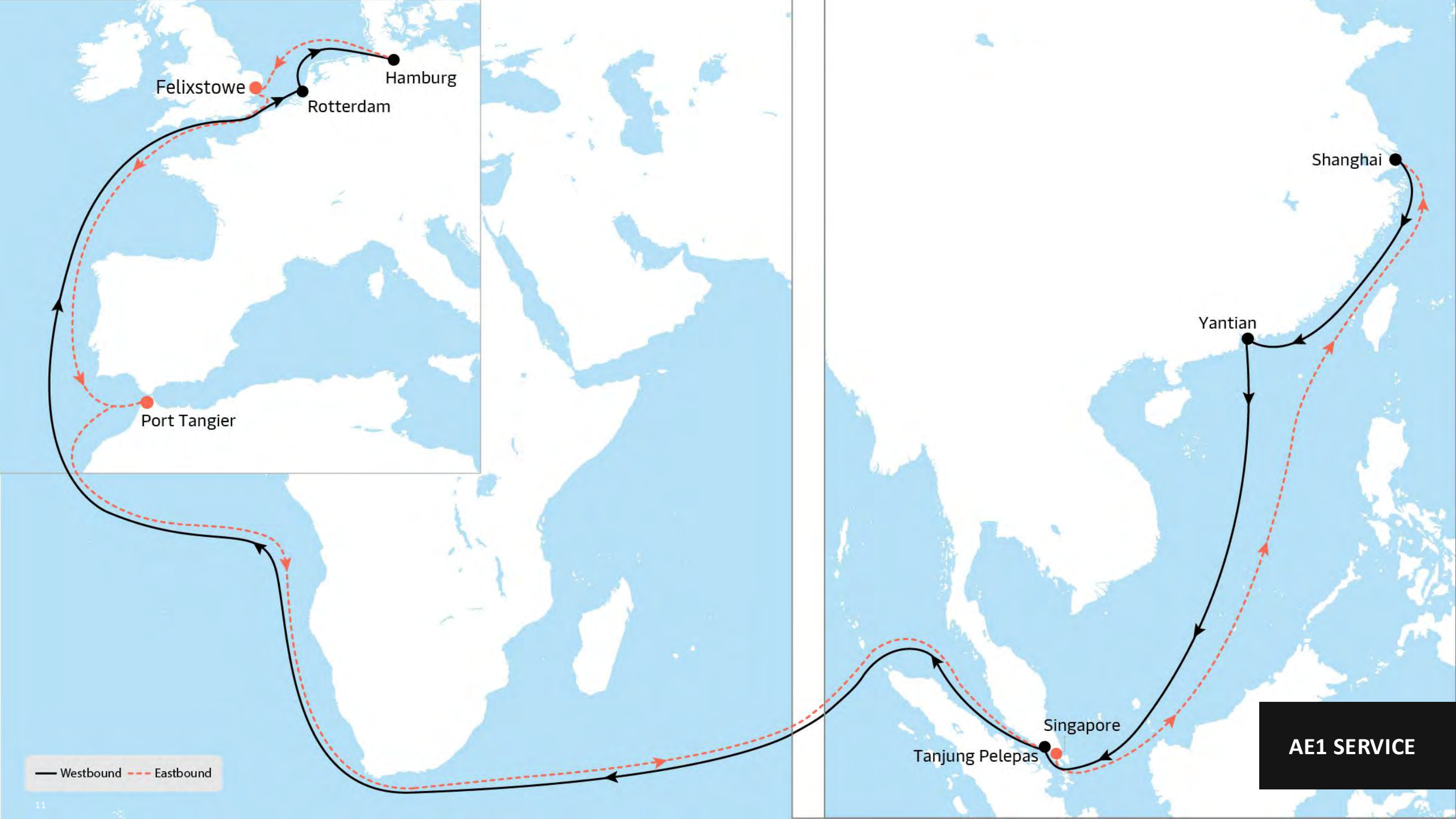

Felixstowe

Rotterdam

Hamburg

Port Tangier

Shanghai

Yantian

Singapore

Tanjung Pelepas

AE1 SERVICE

— Westbound - - - Eastbound

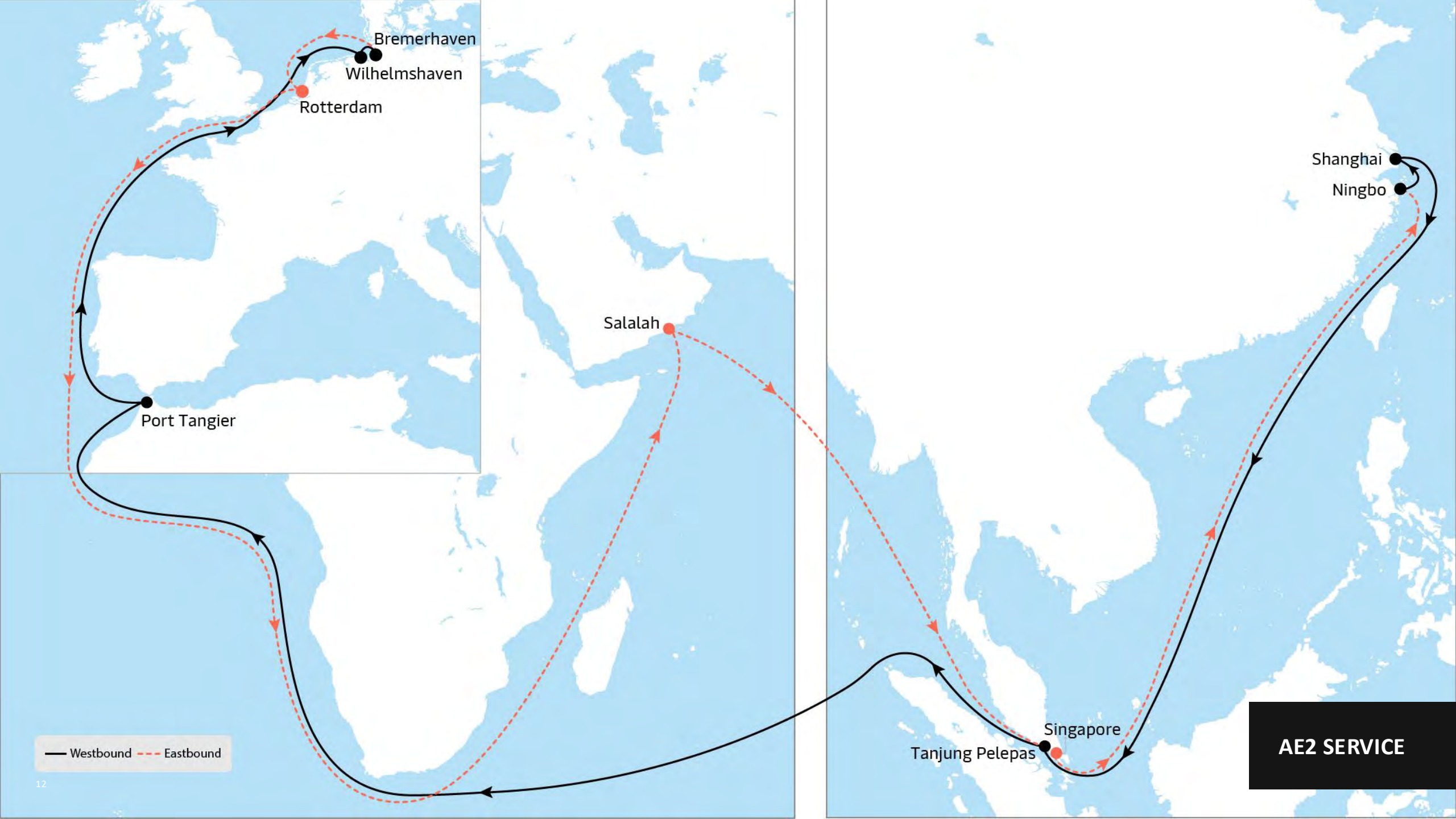



— Westbound - - - Eastbound

AE3 SERVICE





AE11 SERVICE



— Westbound - - - Eastbound

*Certain Port Said EB calls will be transferred to Damietta during 2025.



AE12 SERVICE



AE15 SERVICE

*Certain Port Said EB calls will be transferred to Damietta during 2025.

Asia - Middle East - Highlights

Asia to Middle East/India

- Our improved Asia to Middle East network offers reliable weekly connectivity between Asia and the Arabian Gulf.
- Direct connections from North East Asia, including Japan, China, and South Korea, and South East Asia, including Vietnam, Thailand, and Malaysia, to our main hub at Tanjung Pelepas ensure efficient access to a wide range of markets.
- Our dedicated Asia shuttles provide robust and reliable service linking these regions.
- From Tanjung Pelepas, our mainline services and dedicated Gulf shuttles offer direct, reliable routes to key Middle Eastern ports, including Jebel Ali, Dammam, and Jubail.

Middle East/India to Asia

- Our improved Middle East to Asia network provides reliable weekly connectivity between the Arabian Gulf, Pakistan, India, and key Asian markets.
- Dedicated Middle East shuttles serve the Upper Gulf, Pakistan and the broader Gulf. Strategic hubs enhance network efficiency and connectivity.
- Salalah integrated Pakistan and Gulf services into the broader network, and Tanjung Pelepas facilitates smooth connection between Asia and the Middle East, optimising routes and reducing transit times.

Asia to Middle East (CoGH)

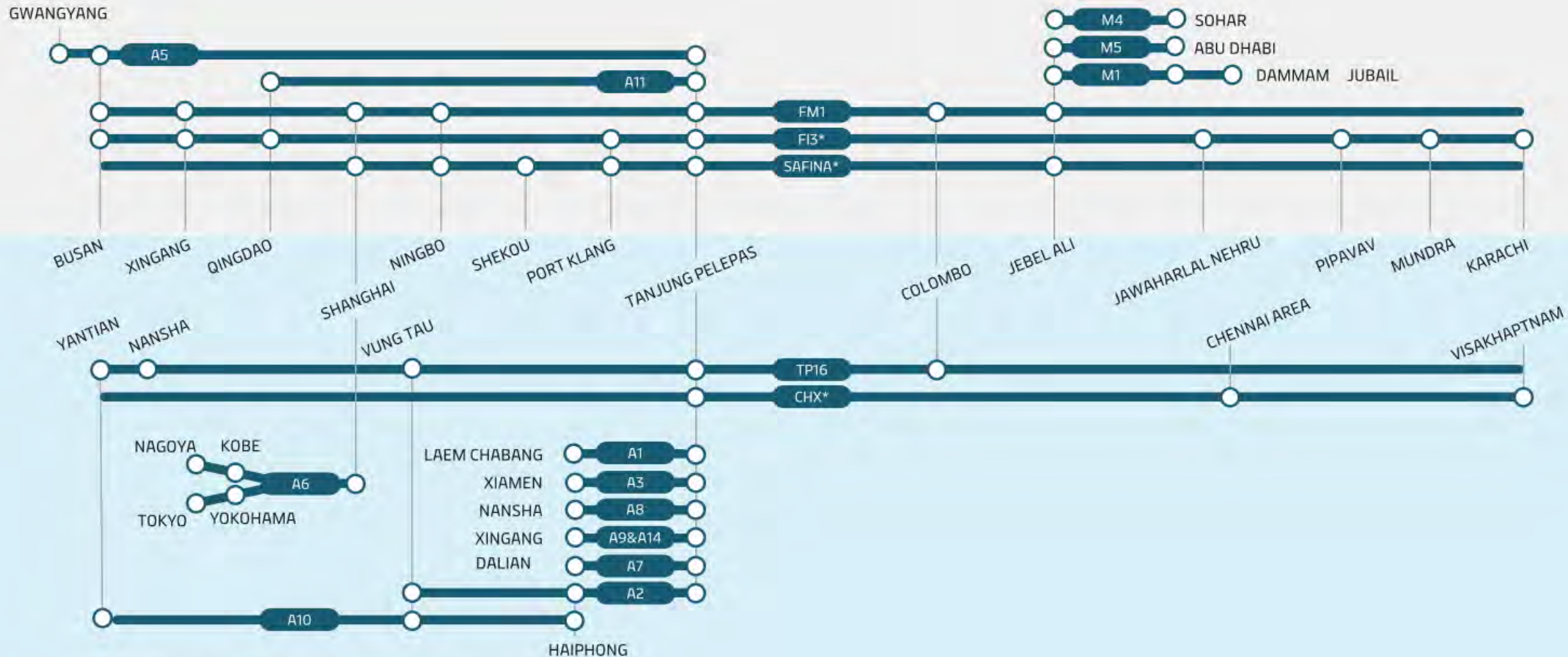

Note: *) Service operated outside the Gemini Cooperation.

Middle East to Asia (CoGH)

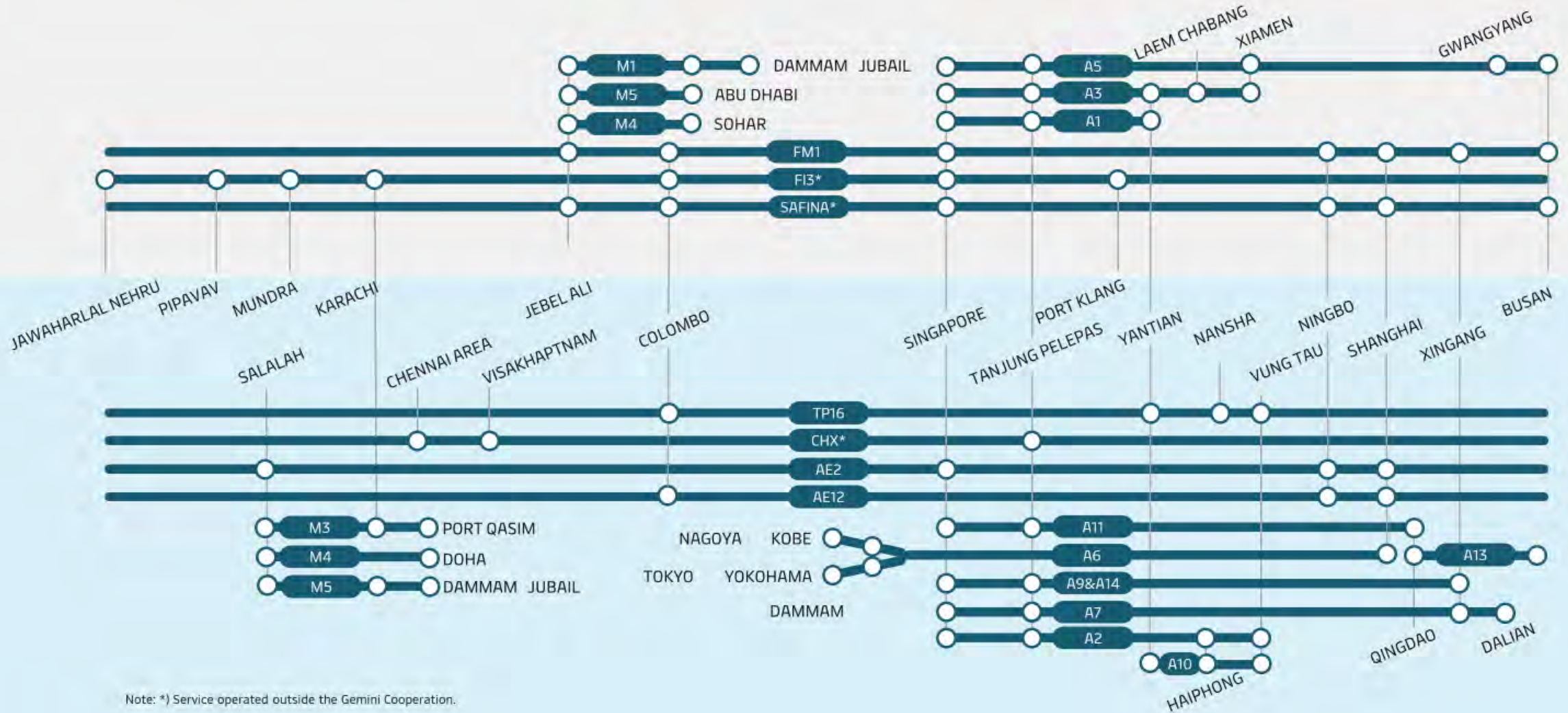

Asia – Middle East

Origin/Destination	Colombo	Jebel Ali	Doha	Dammam
Shanghai	13	19	35	26
Ningbo	17	19	35	26
Qingdao	14	21	37	27
Xingang	17	23	39	29
Laem Chabang	10	20	33	23
Yantian	12	18	35	25
Busan	15	22	38	28

Origin/ Destination	Shanghai	Ningbo	Qingdao	Xingang	Laem Chabang	Yantian	Busan
Colombo	16	10	23	29	24	11	15
Jebel Ali	18	23	25	22	16	23	27
Doha	26	29	30	27	23	30	32
Dammam	32	29	36	34	29	36	38

**Transit time indicative only and subject to change. updated as of 10.09.2024*



Asia to North America - Highlights

Asia to West Coast North America

- Introducing new TP7 with direct coverage from Korea, Japan and Mainland China to Los Angeles with competitive transit time.
- New TP7 offering 2 days faster product from Ningbo to Los Angeles. 3 days faster product offering from Qingdao to Los Angeles and Oakland on a leaner TP8.
- Maintaining the fast and reliable shuttle connections from Southeast Asian ports to main West Coast Gateways.
- Sufficient schedule buffer is added around Prince Rupert and Vancouver to safeguard service reliability and secure weekly connectivity to inland destinations.

Asia to East Coast North America

- Our new Asia to East Coast North America network continues focusing on high service reliability as well as weekly connectivity.
- Direct Busan call on TP12 provides competitive transit times to Newark and Norfolk.
- Direct Ningbo call on TP15 to offer direct products to US Gulf area.
- Maintaining reliable weekly connectivity between East and South China into US East Coast gateways.
- Schedule buffer added to Shanghai, Ningbo and Busan port in Asia, and Houston, Savannah, Charleston port in North America to safeguard service reliability
- Wilmington, New Orleans & Tampa coverage via transshipment in Cartagena, Colombia

Asia to North America (CoGH)

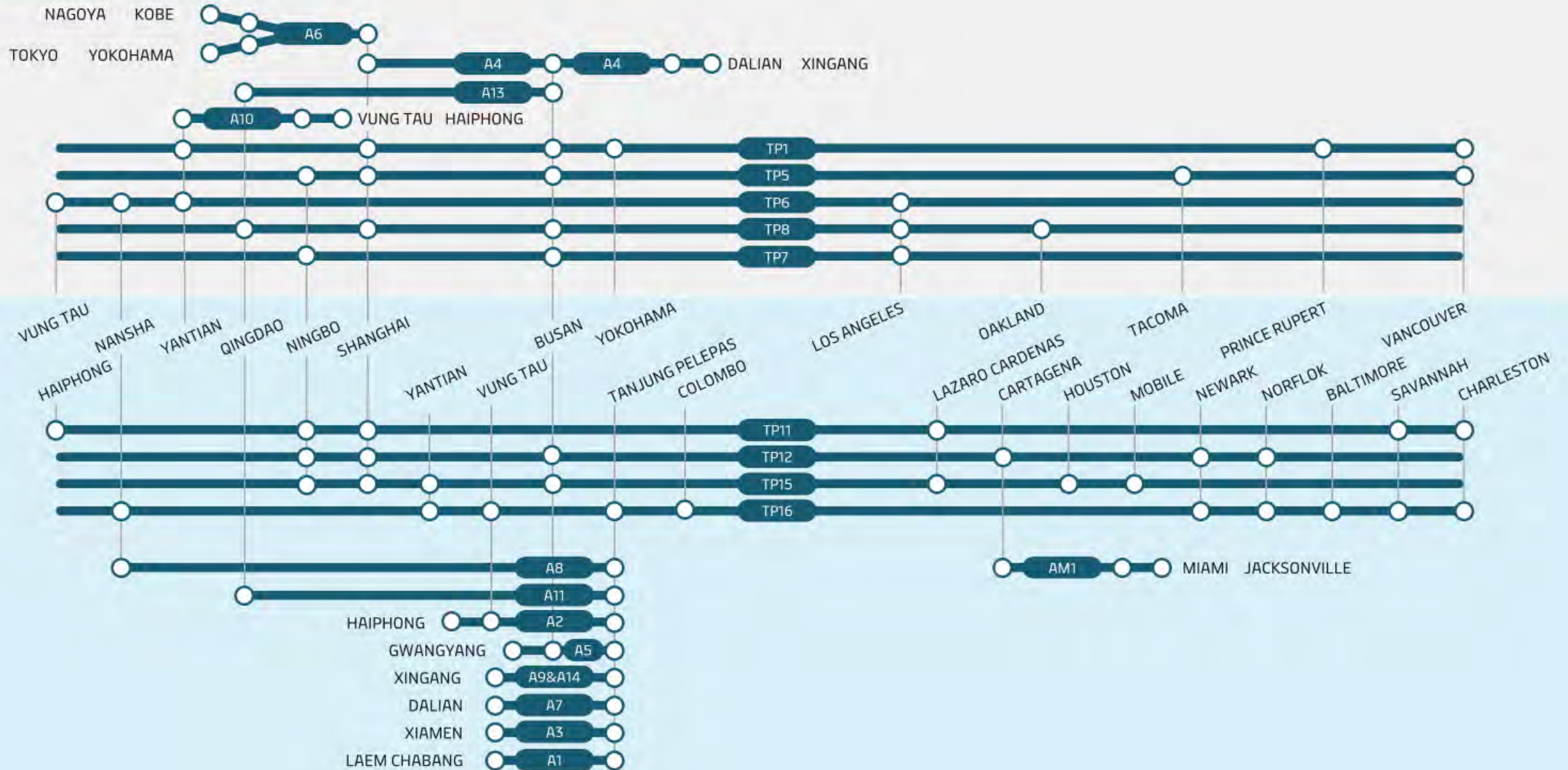

Transpacific

Origin/ Destination	Los Angeles	Oakland	Tacoma	Vancouver	Prince Rupert	Newark	Norfolk	Charleston	Savannah	Baltimore	Houston
Yantian	16	29	20	28	23	36	39	37	34	47	35
Shanghai	17	27	16	25	19	34	38	32	29	39	31
Ningbo	15	31	21	30	25	38	41	36	34	47	35
Qingdao	22	31	17	26	21	39	42	40	43	52	37
Xingang	17	26	19	28	18	34	38	41	38	50	32
Busan	14	23	12	21	16	29	33	31	29	51	29
Vung Tau	23	39	31	40	30	36	39	45	43	42	44
Haiphong	24	34	27	36	31	37	40	41	39	47	40
Laem Chabang	25	35	28	36	31	38	42	50	45	45	42

**Transit time indicative only and subject to change. updated as of 10.09.2024*

North America to Asia - Highlights

West Coast North America to Asia

- Our new West Coast North America to Asia network offers reliable and fast weekly connectivity from Pacific West for your supply chain.
- Significant improvement on the product offering with transit time reductions of up to 7 days.
- Extending direct coverage between Tacoma, Vancouver to Japan area with compelling transit time.
- New TP7 will provide fast service from Los Angeles to Japan and Korea.

East Coast North America to Asia

- Our latest East Coast North America to Asia network focuses on reliable connections and competitive transit times
- This provides flexibility for your supply chain and improvement on the product offering with an overall transit time reduction of 2 days.
- Maintaining the extensive Asia coverage from US Gulf and US East Coast through our Asia shuttle network.

North America to Asia (CoGH)

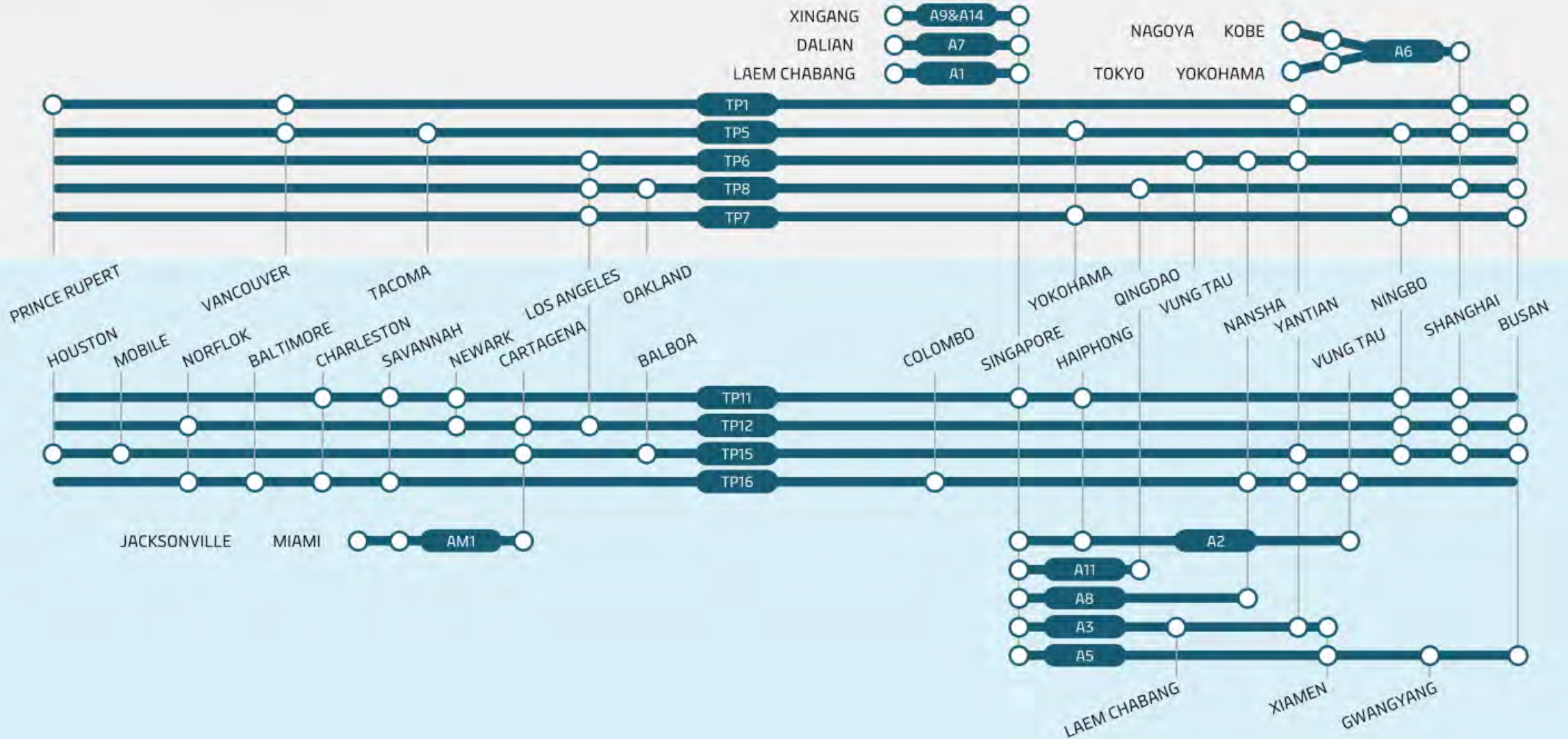

Origin/ Destination	Yantian	Shanghai	Ningbo	Qingdao	Xingang	Busan	Vung Tau	Haiphong	Laem Chabang
Los Angeles	31	19	16	21	26	15	25	30	34
Oakland	49	23	29	20	39	25	48	43	38
Tacoma	25	26	23	34	39	28	30	39	41
Vancouver	15	18	15	26	30	19	19	29	29
Prince Rupert	27	30	27	44	45	32	32	42	41
Newark	36	40	36	40	39	44	44	41	40
Norfolk	48	40	38	49	52	45	61	49	54
Charleston	40	45	41	45	44	49	49	46	45
Savannah	40	42	41	47	45	45	48	48	47
Baltimore	55	48	44	63	65	60	60	64	57
Houston	46	37	40	48	53	42	52	49	47

**Transit time indicative only and subject to change. Updated as of 10.09.2024*

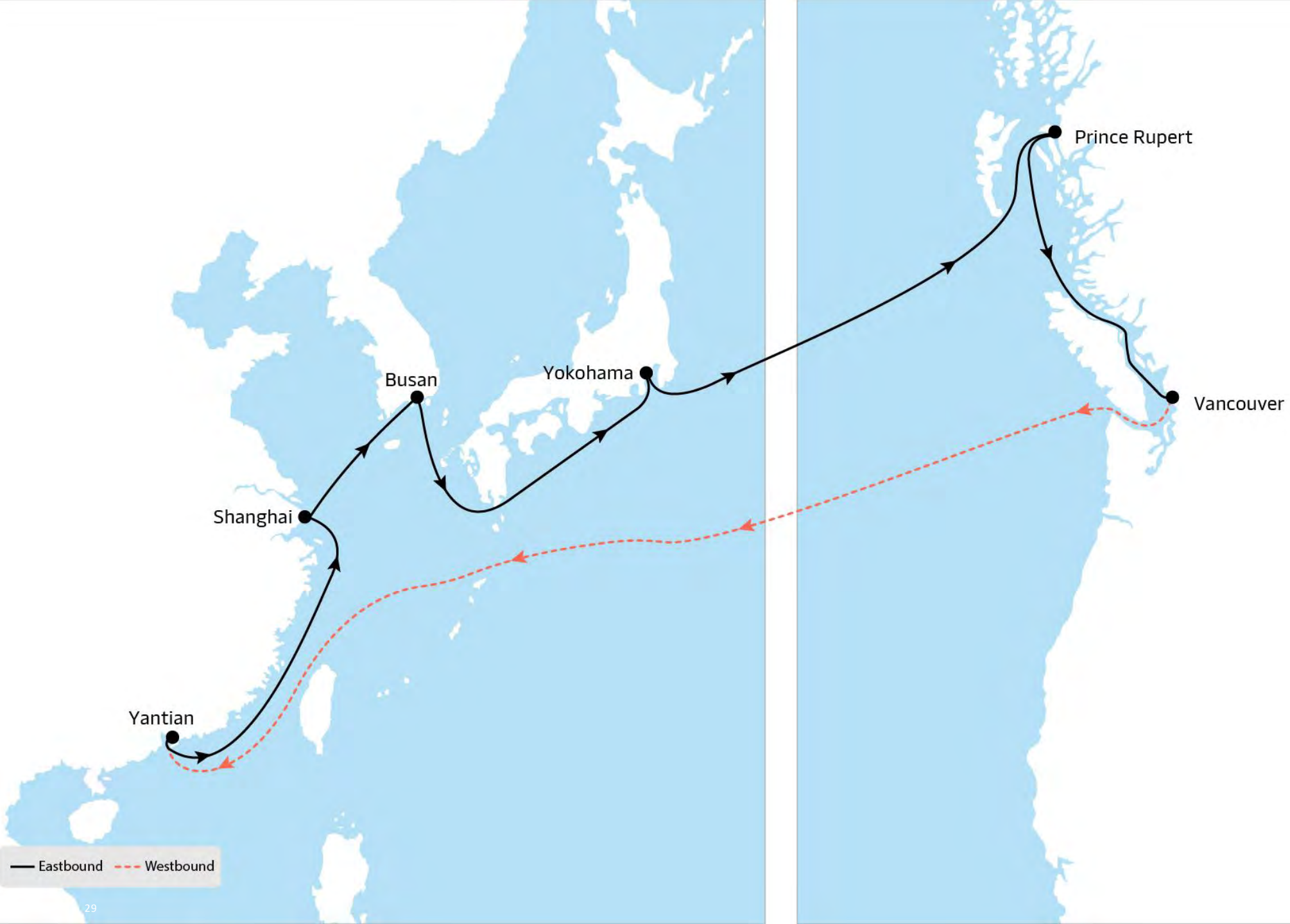

— Eastbound - - - Westbound

TP1 SERVICE

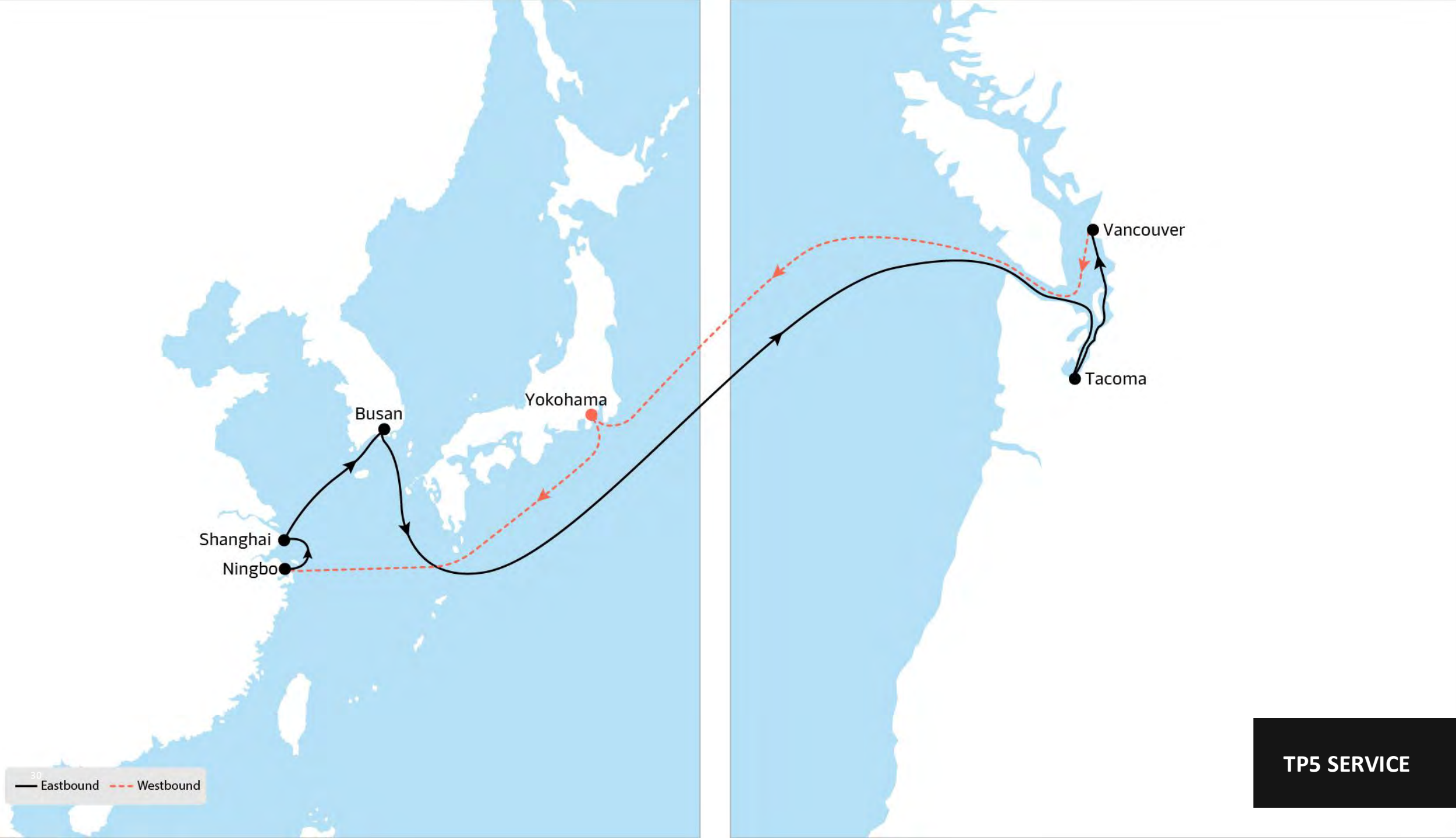

TP5 SERVICE

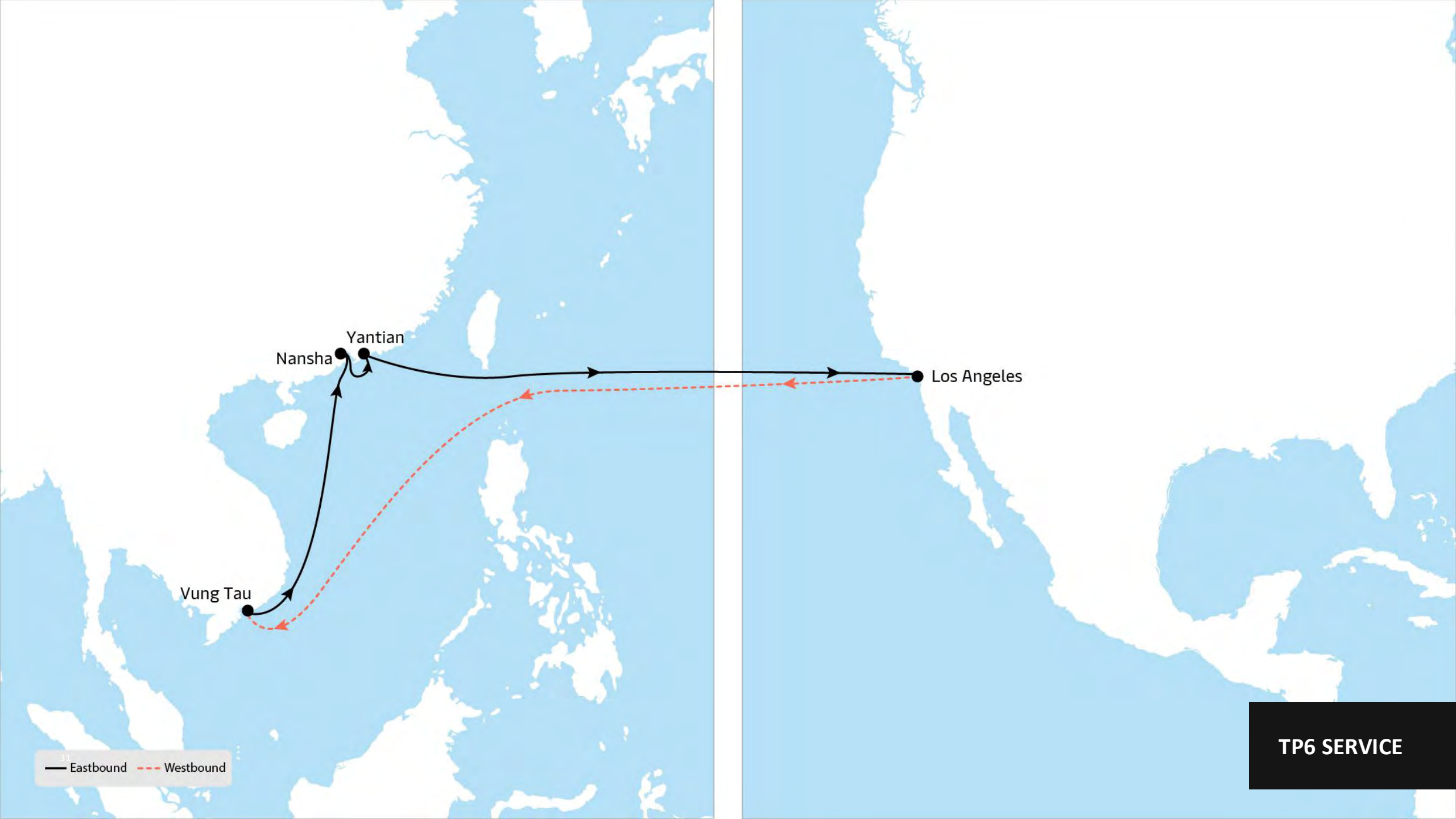

Nansha
Yantian

Los Angeles

Vung Tau

— Eastbound - - - Westbound

TP6 SERVICE

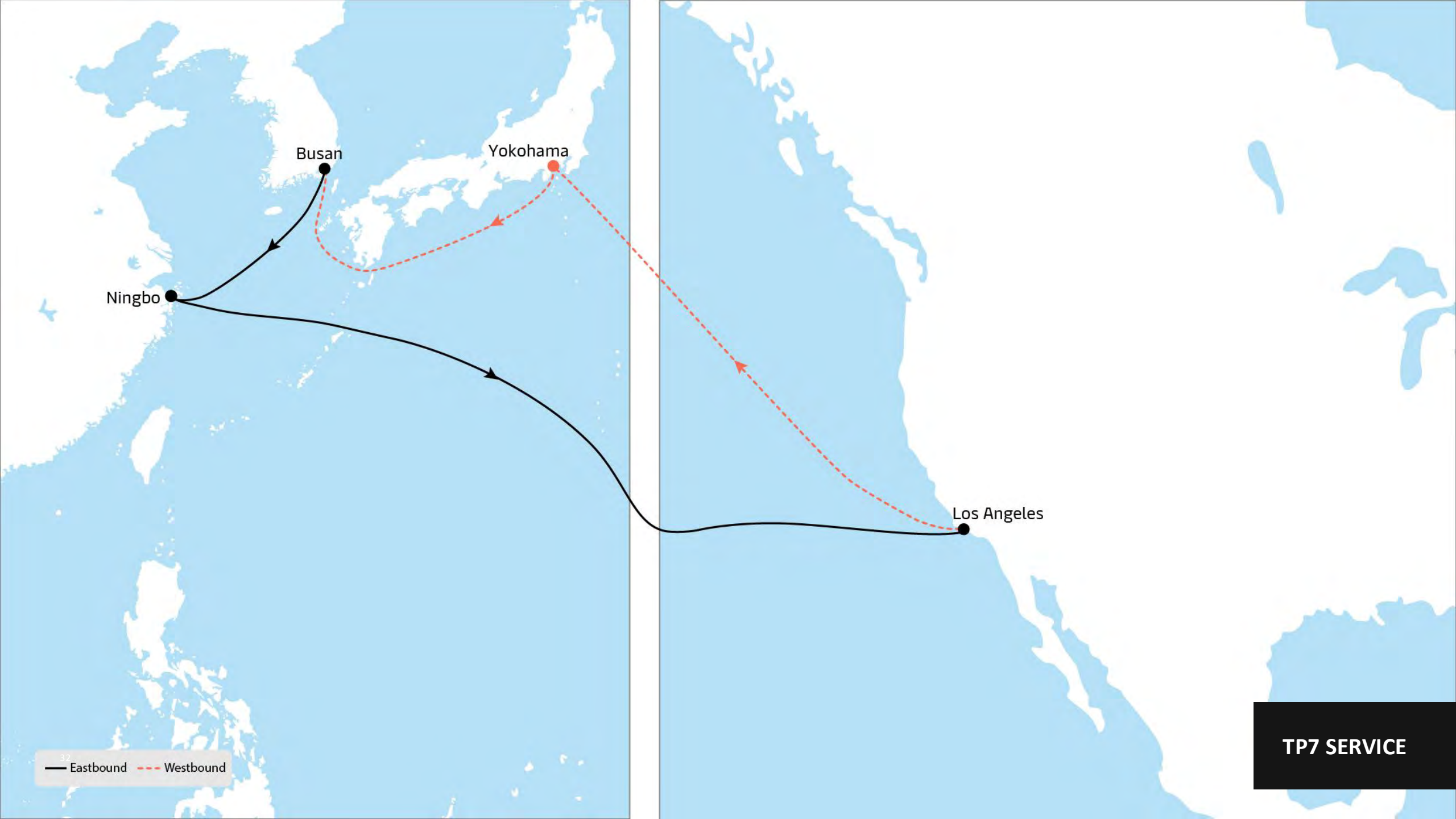

32
— Eastbound - - - Westbound

TP7 SERVICE

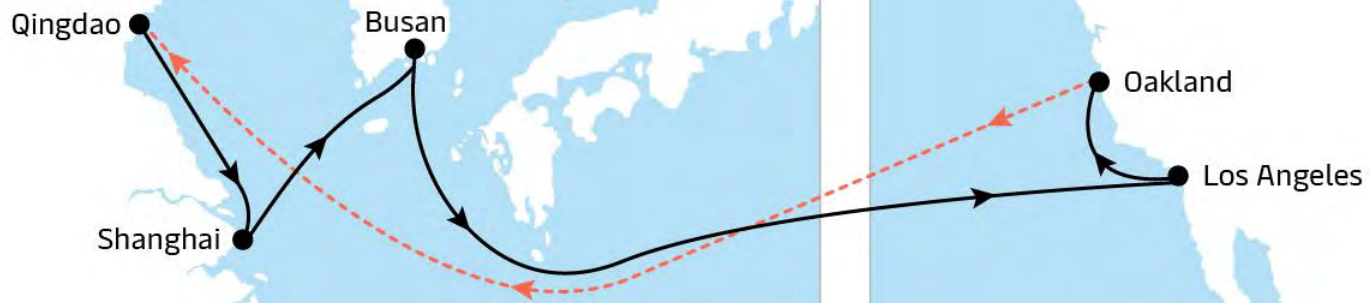

— Eastbound - - - Westbound

TP8 SERVICE

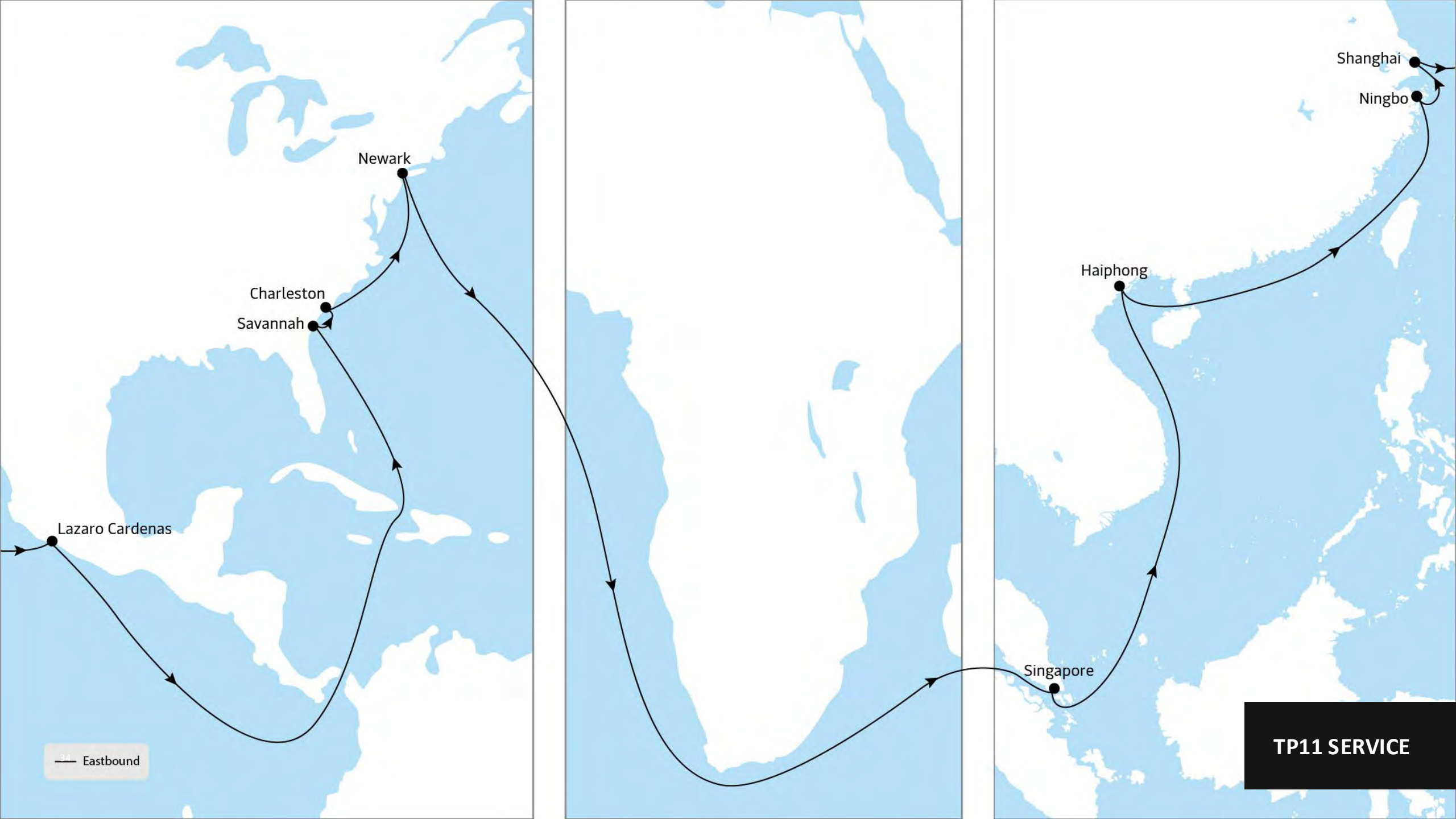

Newark

Charleston
Savannah

Lazaro Cardenas

Haiphong

Singapore

Shanghai

Ningbo

— Eastbound

TP11 SERVICE

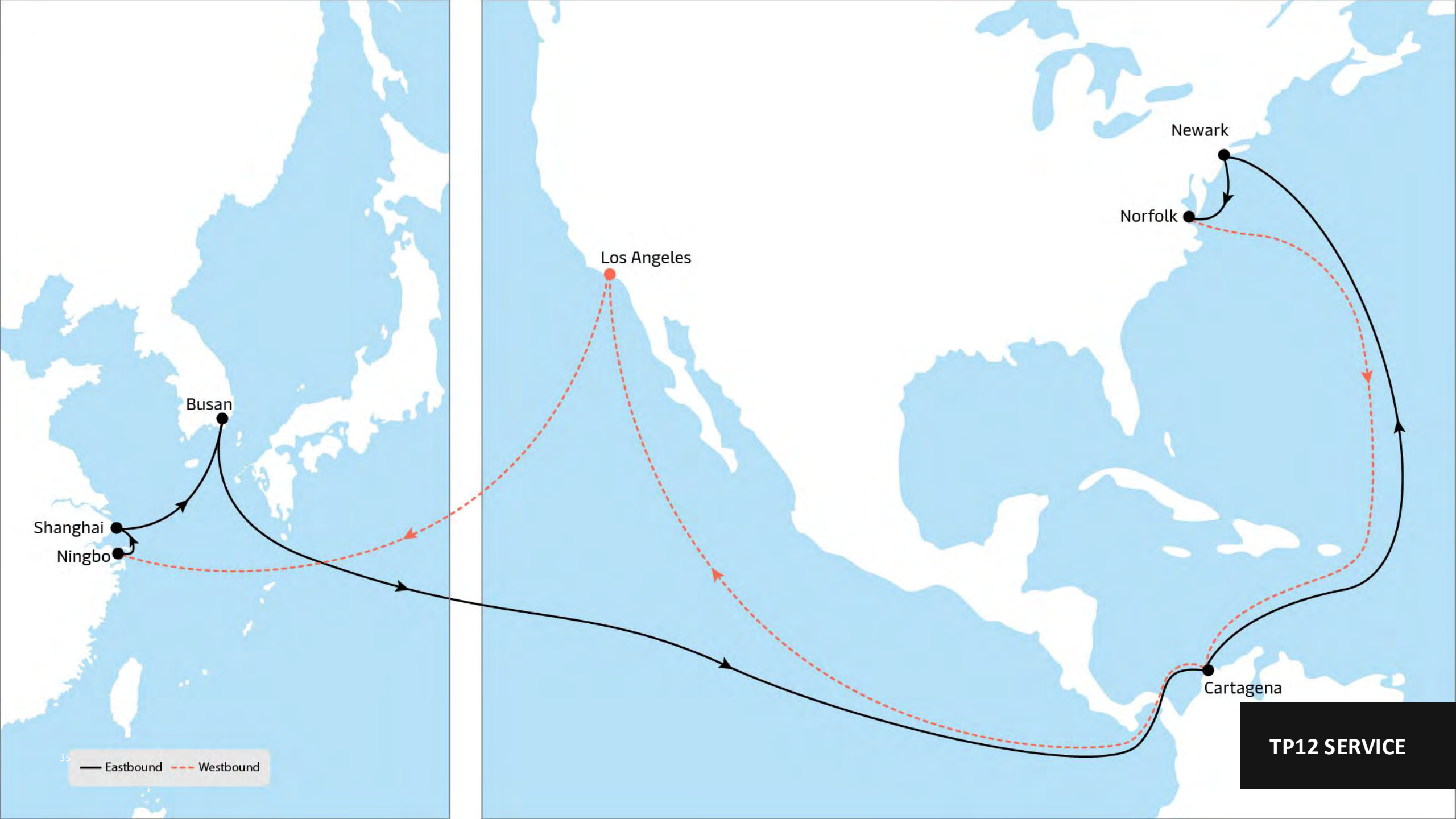

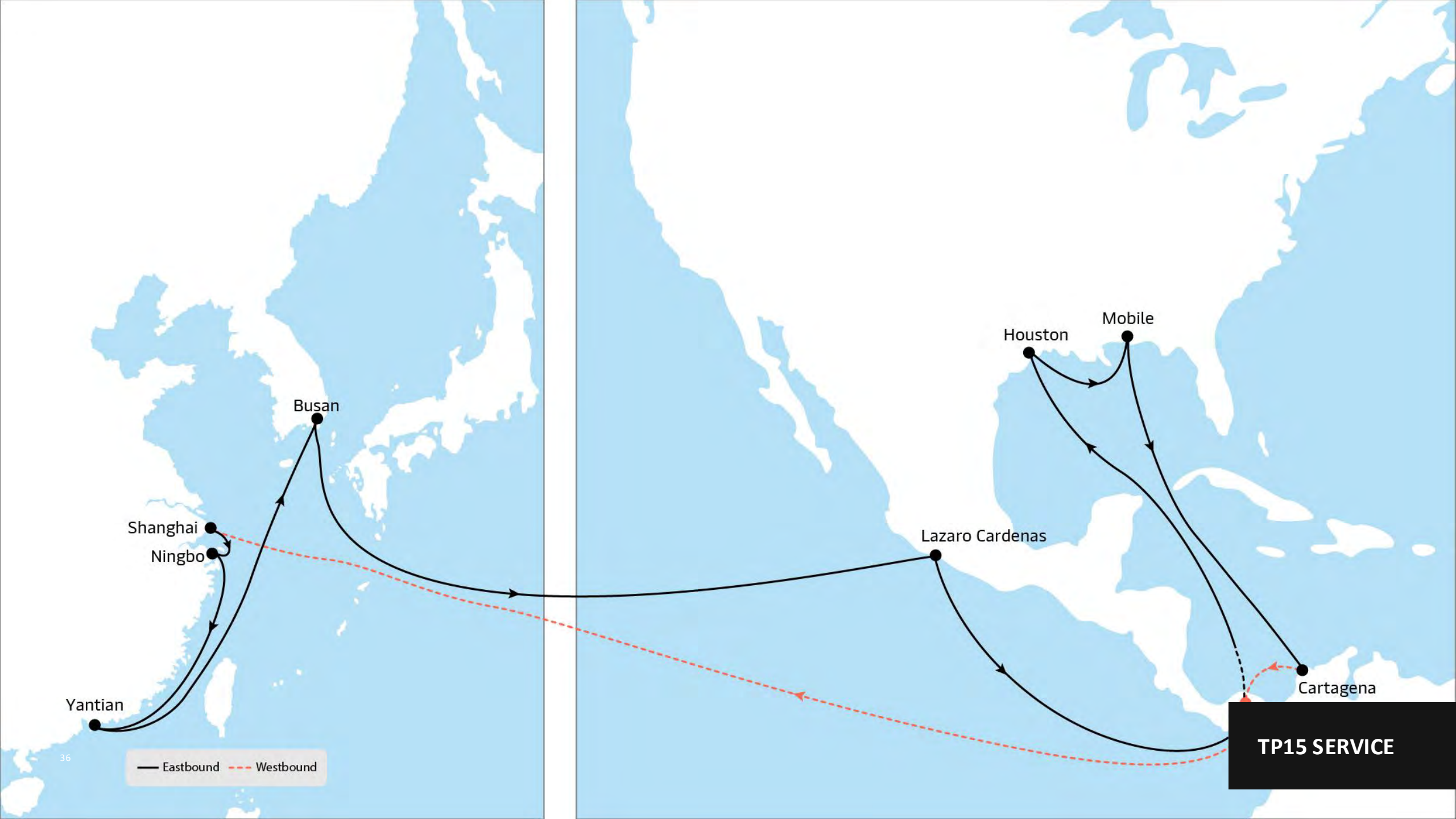

— Eastbound - - - Westbound

TP15 SERVICE



— Westbound - - - Eastbound

TP16 SERVICE

Europe - North America – Highlights

Europe to North America

- Extensive Germany coverage
- Connecting UK directly to North America through Southampton.
- Hamburg added to the Transatlantic network as a central gateway.
- New product coverage into Philadelphia.
- Direct connection from North Europe into Miami.
- A Dedicated Mexico/US Gulf service.
- Additional Newark coverage from Bremerhaven by Maersk operated Europe to Latin America Services.
- New product coverage into Philadelphia.

North America to Europe

- Our new Transatlantic network offers reliable weekly connectivity between North America to key European gateways.
- Extensive Germany coverage.
- New product coverage from Philadelphia and St. John.
- Direct connection to UK through Southampton.
- Direct connection to North Europe from Miami.
- A dedicated Mexico/US Gulf service.

Europe to North America (CoGH)

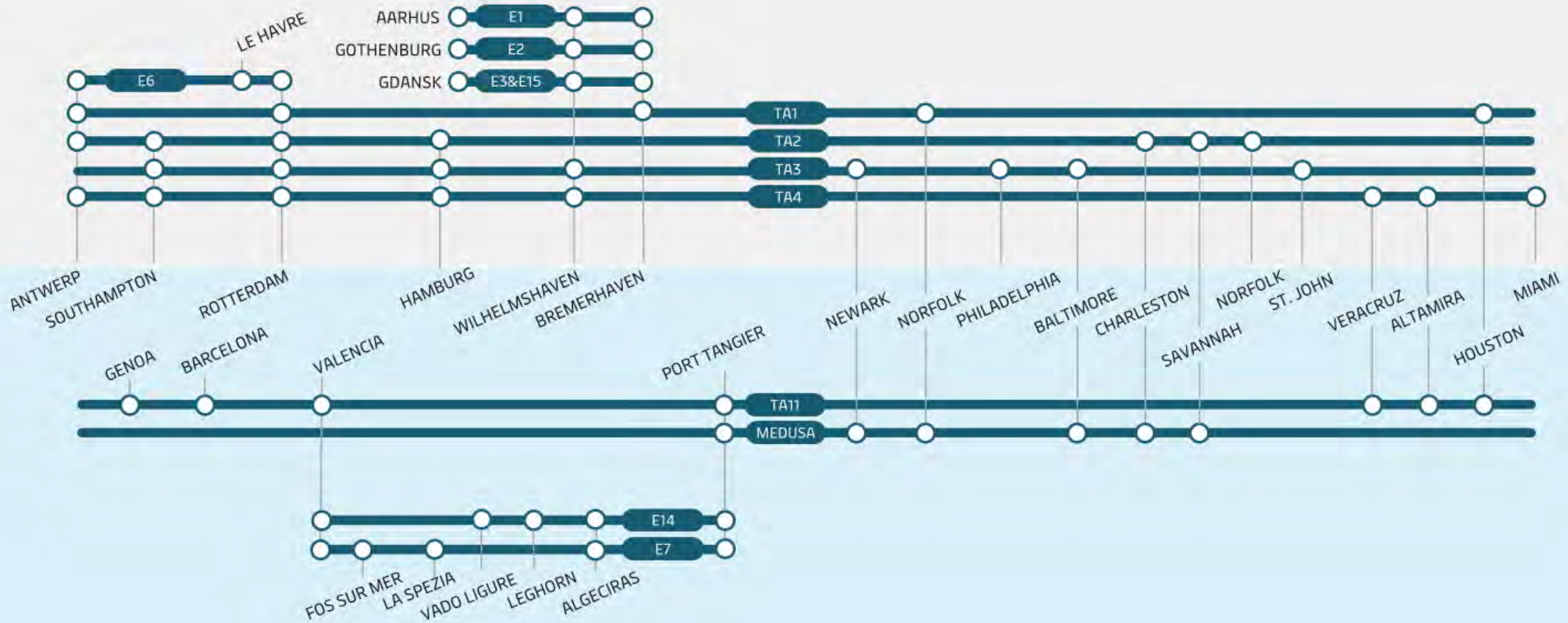

North America to Europe (CoGH)

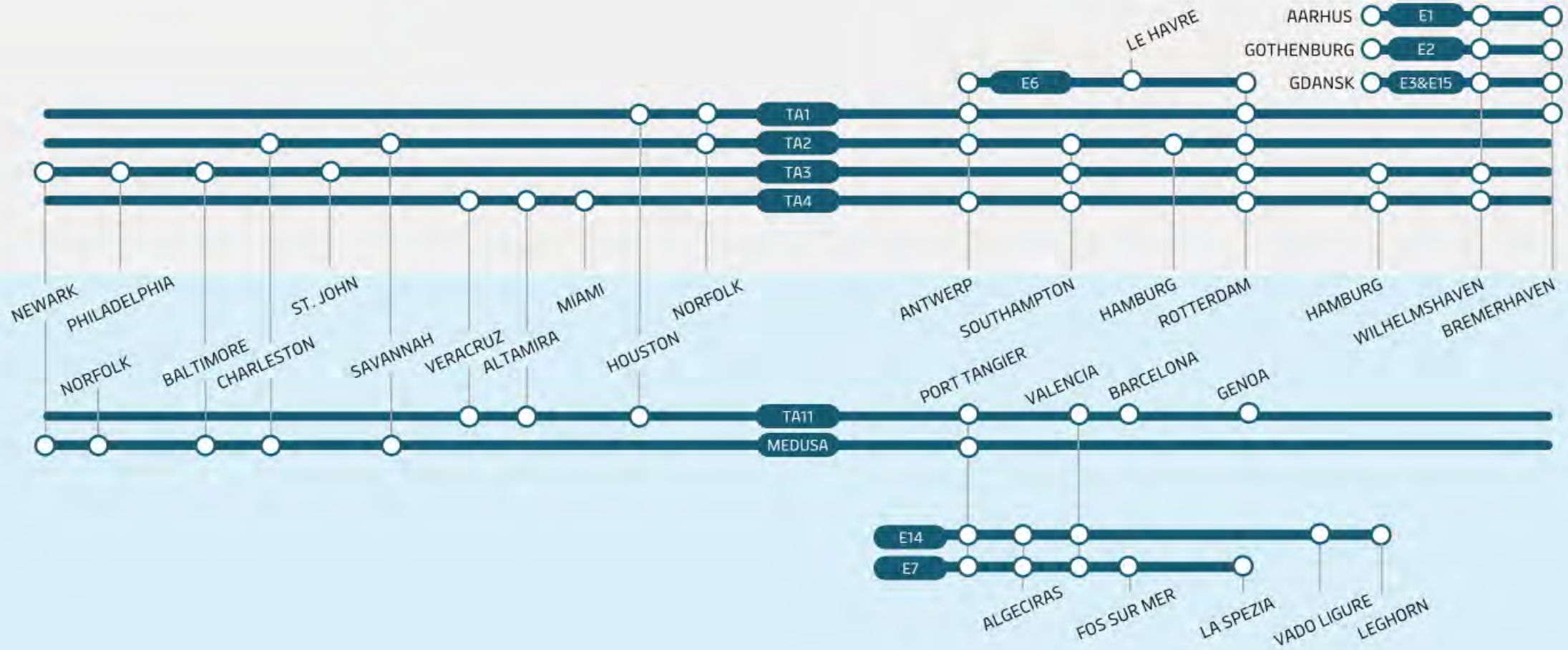

Transatlantic

Origin/Destination	Newark	Norfolk	Charleston	Savannah	Baltimore	Houston	Veracruz	Altamira
Antwerp	18	15	18	21	23	22	19	21
Southampton	17	20	16	21	23	27	22	26
Bremerhaven	11	9	15	18	28	16	23	27
Hamburg	13	24	13	17	21	25	15	18
Rotterdam	16	13	10	15	24	20	18	22
Le Havre	15	22	16	21	22	30	23	25
Genoa	13	17	27	29	20	26	20	22
Leghorn	19	25	31	36	24	28	20	22
Valencia	15	19	28	34	21	23	15	18
La Spezia	14	20	26	27	19	30	22	25

Origin/ Destination	Antwerp	Southampton	Bremerhaven	Hamburg	Rotterdam	Le Havre	Genoa	Leghorn	Valencia	La Spezia
Newark	23	22	30	25	22	29	38	39	33	37
Norfolk	10	13	15	15	13	13	27	27	24	28
Charleston	17	22	24	24	22	23	26	29	23	28
Savannah	15	18	23	21	18	19	19	22	17	21
Baltimore	21	17	28	19	15	25	32	35	30	34
Houston	16	23	21	22	19	22	19	23	16	23
Veracruz	26	24	34	31	28	30	27	33	24	32
Altamira	23	21	31	28	25	27	25	31	22	30

*Transit time indicative only and subject to change. updated as of 10.09.2024

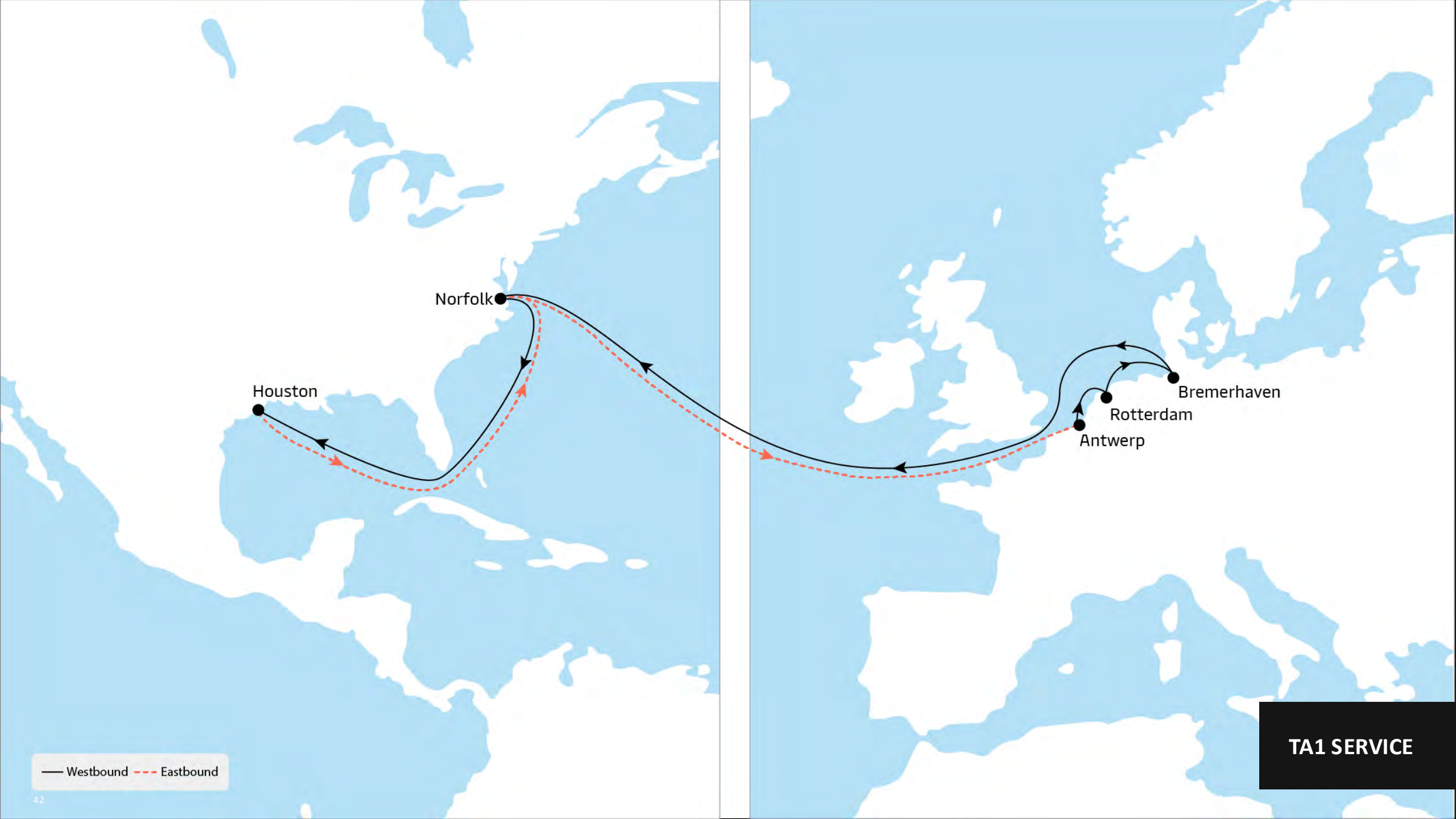

Norfolk

Houston

Bremerhaven
Rotterdam
Antwerp

— Westbound - - - Eastbound

TA1 SERVICE

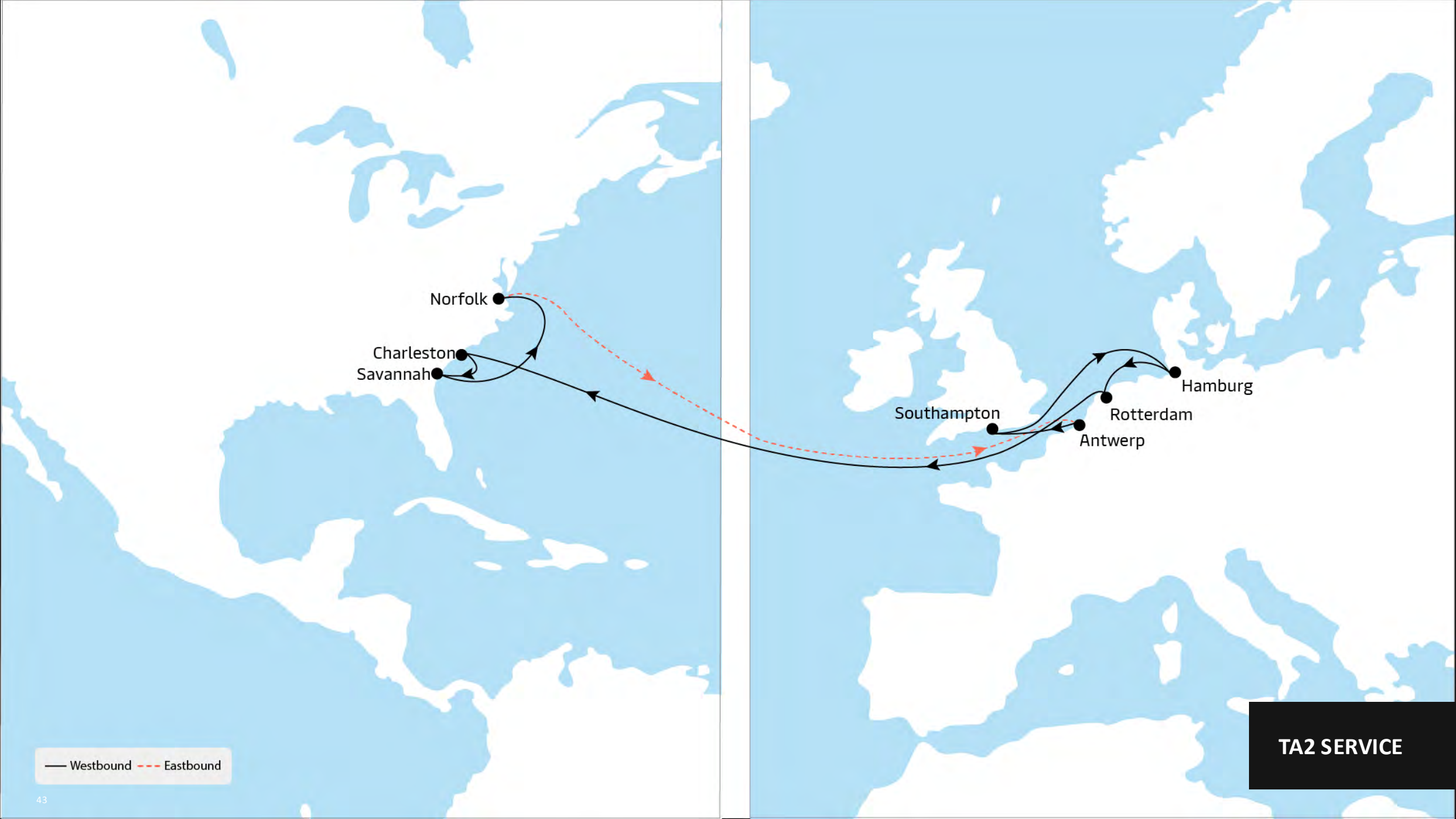

TA2 SERVICE



Saint John

Newark

Philadelphia
Baltimore

Southampton

Rotterdam

Hamburg
Wilhelmshaven

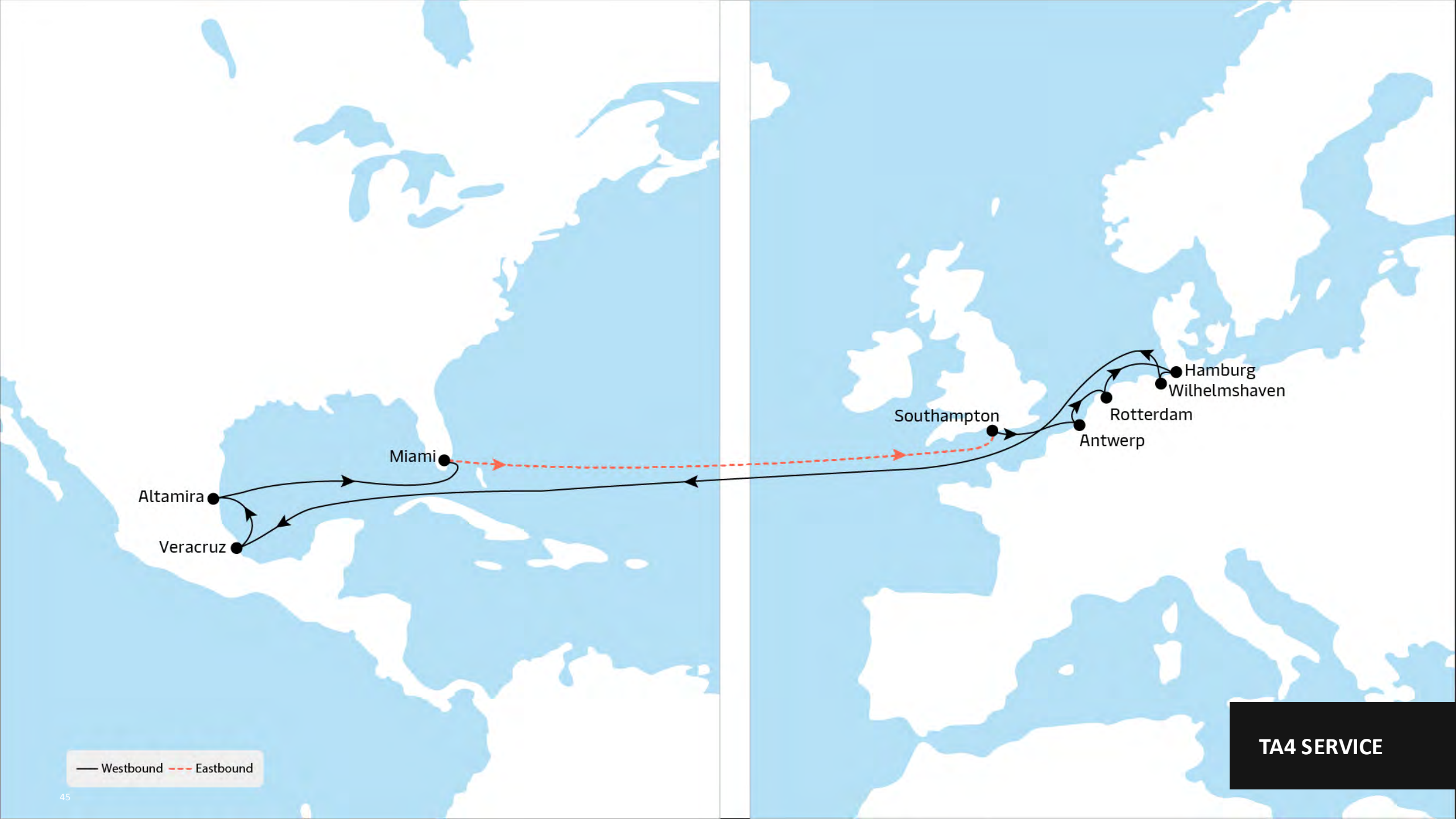

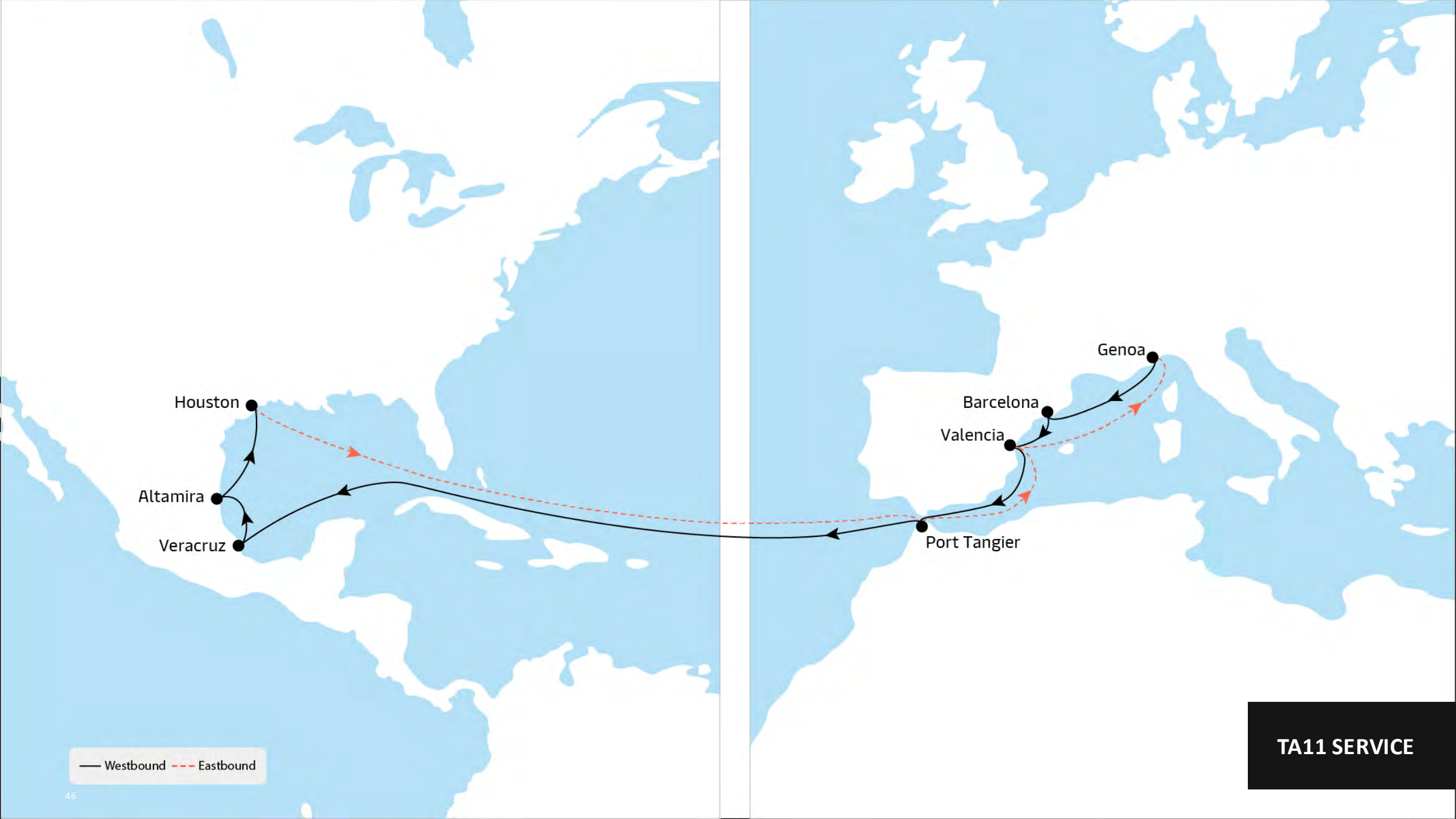

Houston

Altamira

Veracruz

Barcelona

Valencia

Port Tangier

Genoa

— Westbound - - - Eastbound

TA11 SERVICE



MEDUSA SERVICE

Middle East/India - Europe - Highlights

Middle East to Europe

- Our improved Middle East to Europe network offers industry leading reliability and extensive weekly connectivity between India and the Middle East to North Europe and the Mediterranean
- Two dedicated North Europe services from India (South-East and North-West India). Bangladesh will continue to be served via Colombo on the South-East India service with improved connectivity and higher reliability.
- Best in class product offering to Jeddah with 3 dedicated services, with improved coverage to Spain and Italy with Eastern mediterranean served on our extensive shuttle network via Port said.

Europe to Middle East

- Our improved Europe to Middle East network offers reliable and extensive weekly connectivity between North Europe and the Mediterranean to India and the Middle East.
- New compelling product offering between North Europe to West India and East India with Two dedicated North Europe services.
- Best in class product offering to Jeddah with 3 dedicated services, offering improved coverage from Spain and Italy with Eastern mediterranean served on our extensive shuttle network via Port said.

Middle East - India to Europe (CoGH)

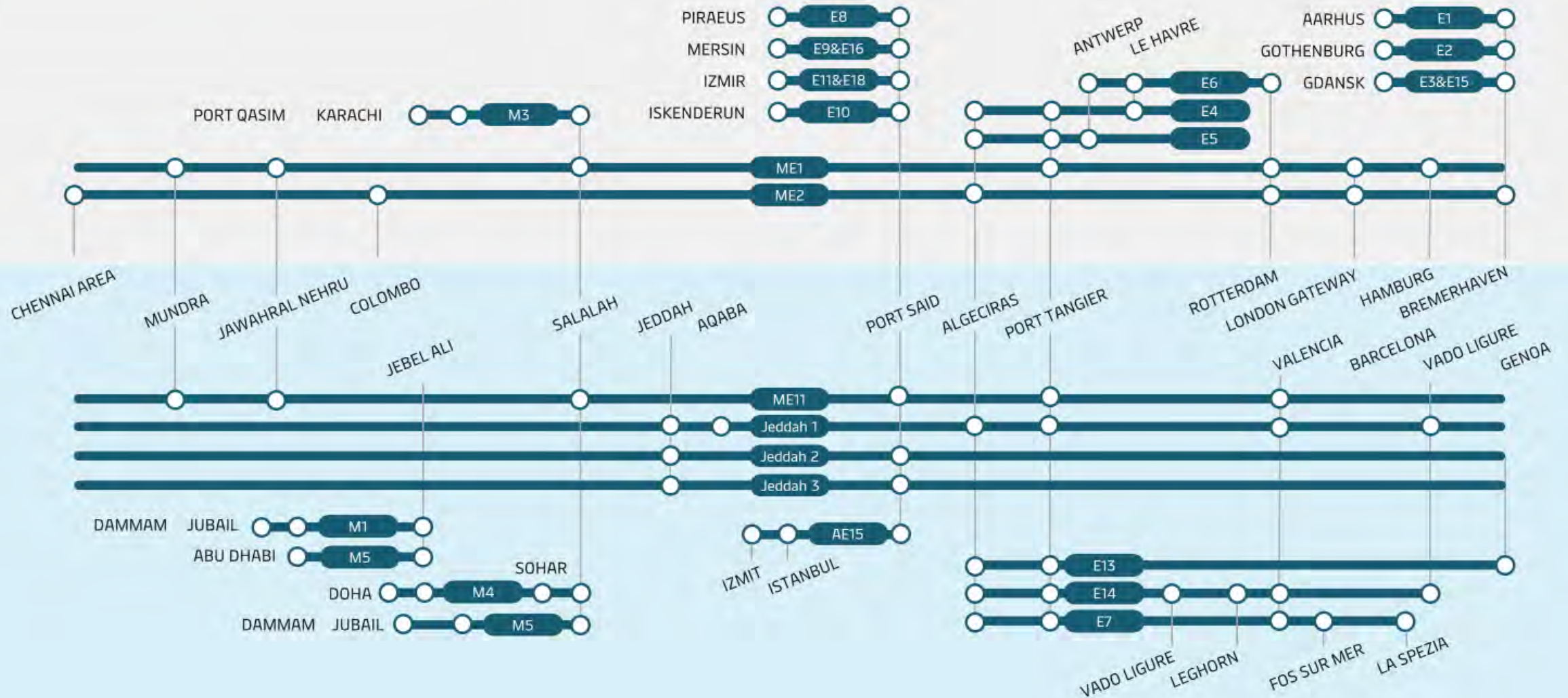

Europe to Middle East - India (CoGH)

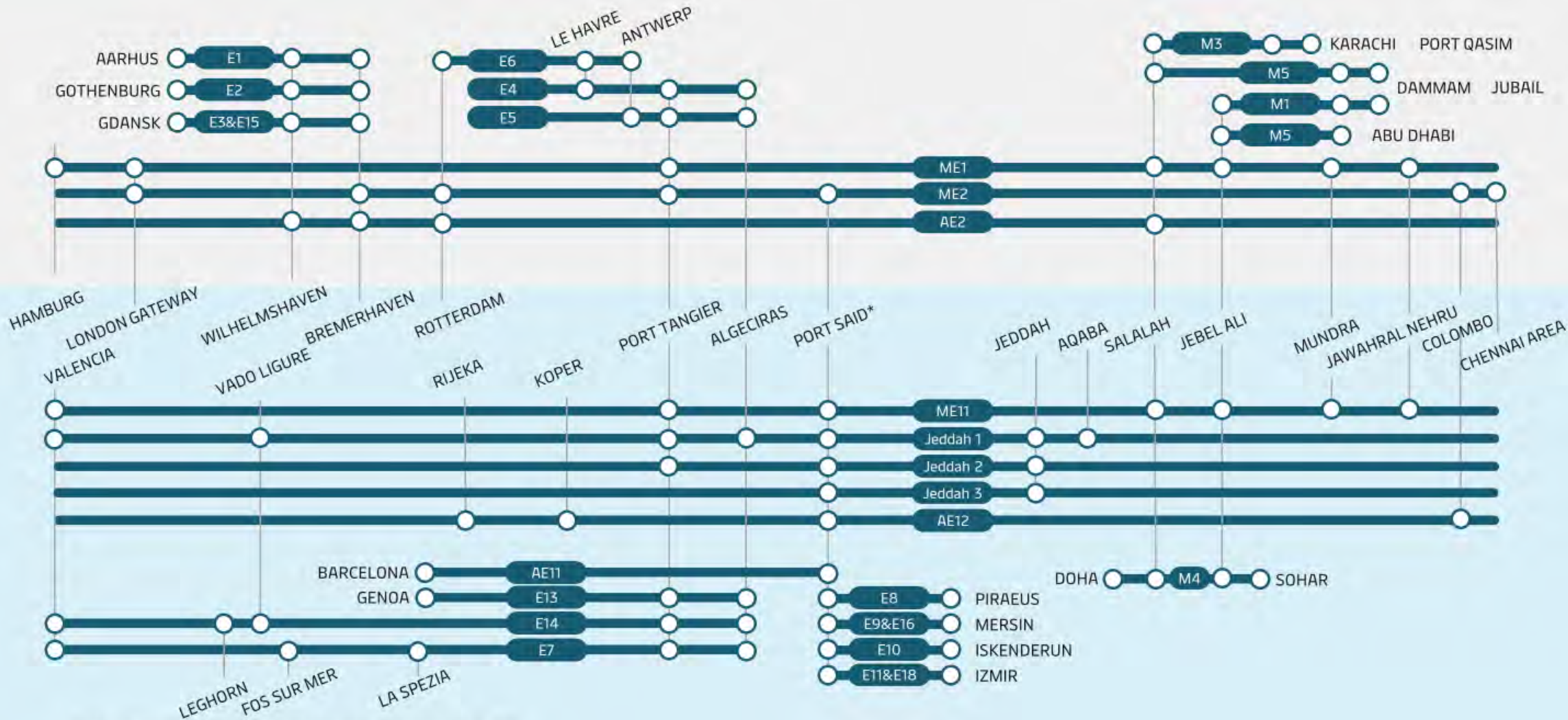

Note: * Certain Port Said EB calls will be transferred to Damietta during 2025.

Middle-East - Europe

Origin/ Destination	Rotterdam	Bremerhaven	London Gateway	Antwerp	Gdansk	Valencia	Genoa Vado Ligure	Barcelona	Mersin	Port Said East	Ambarli Port Istanbul
Jawaharlal Nehru	33	38	41	35	40	30	32	35	43	36	45
Mundra	37	41	45	41	44	33	36	38	46	39	49
Port Qasim	41	41	49	43	52	34	36	38	48	40	50
Ennore Chennai	32	36	34	36	43	31	35	37	55	38	64
Colombo	28	32	30	31	39	27	31	33	51	34	46
Jebel Ali	37	43	45	39	48	38	39	41	51	40	53
Abu Dhabi	35	42	43	38	46	34	37	39	49	39	52
Jeddah	19	19	21	22	22	13	14	16	8	2	10
Jubail	42	42	50	45	53	35	37	39	49	40	52
Doha	38	45	47	41	49	38	40	42	52	42	55

**Transit time indicative only and subject to change. updated as of 10.09.2024*

Europe – Middle East

Origin/ Destination	Jawaharlal Nehru	Mundra	Port Qasim	Ennore Chennai	Colombo	Jebel Ali	Doha	Jeddah	Dammam
Rotterdam	37	34	37	32	29	30	32	18	33
Bremerhaven	40	37	40	35	32	33	35	22	36
London Gateway	39	36	39	39	36	32	34	18	36
Antwerp	44	42	43	36	33	37	38	17	39
Gdansk	51	48	50	43	40	44	45	30	46
Valencia	38	35	36	32	29	30	36	9	36
Genoa Vado Ligure	45	42	45	37	34	37	40	7	41
Barcelona	41	38	41	33	30	33	36	15	37
Mersin	51	48	49	40	34	42	51	11	48
Port Said East	45	41	42	36	30	36	42	2	42
Ambarli Port Istanbul	52	49	49	42	36	43	51	13	49

**Transit time indicative only and subject to change. updated as of 10.09.2024*





ME2 SERVICE



ME11 SERVICE

*Certain Port Said EB calls will be

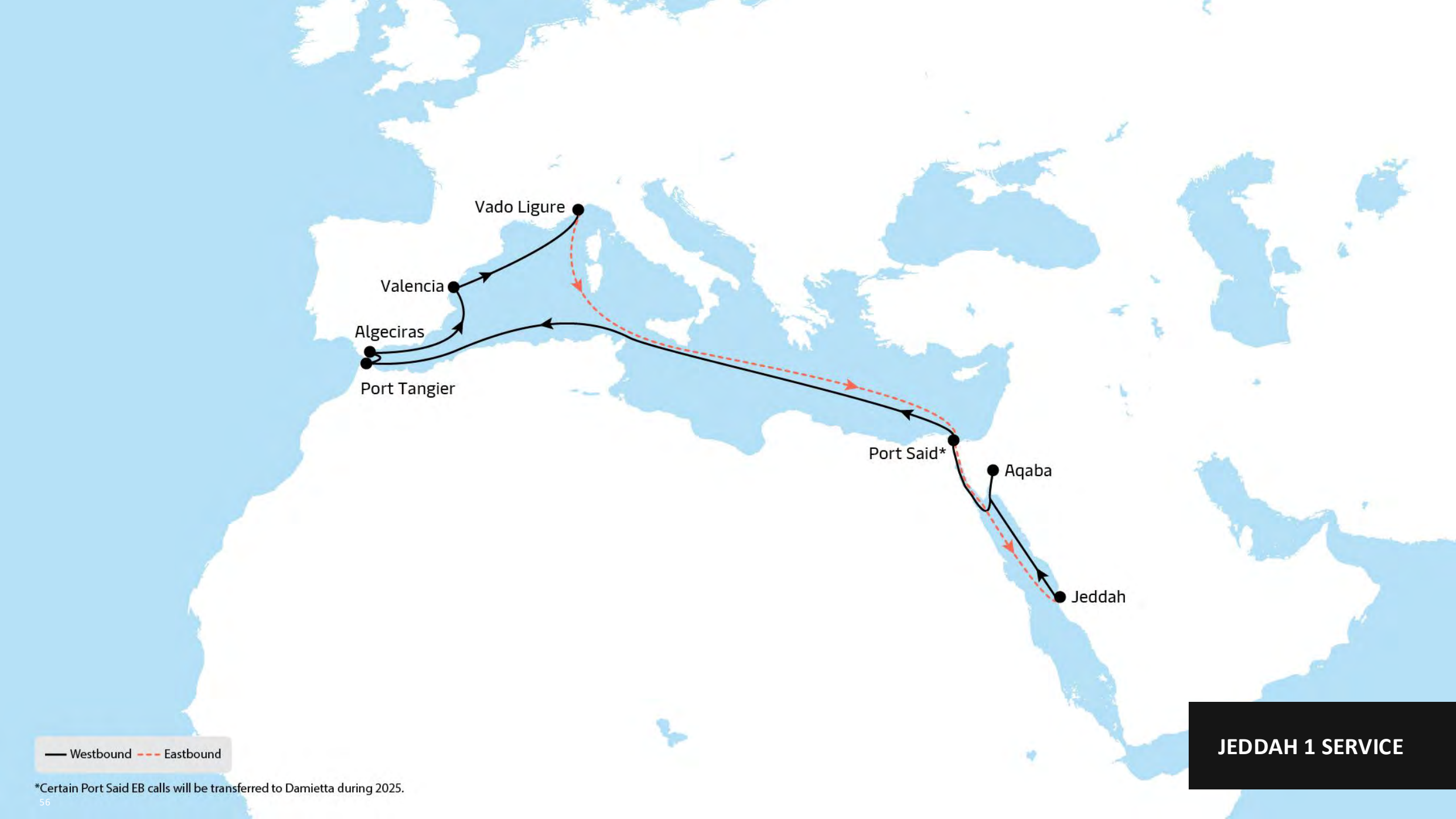

— Westbound - - - Eastbound

JEDDAH 1 SERVICE

*Certain Port Said EB calls will be transferred to Damietta during 2025.



Port Tangier

Port Said*

Jeddah

— Westbound - - - Eastbound

JEDDAH 2 SERVICE

*Certain Port Said EB calls will be transferred to Damietta during 2025.



Port Said*

Jeddah

— Westbound - - - Eastbound

JEDDAH 3 SERVICE

*Certain Port Said EB calls will be transferred to Damietta during 2025.

Shuttle service maps

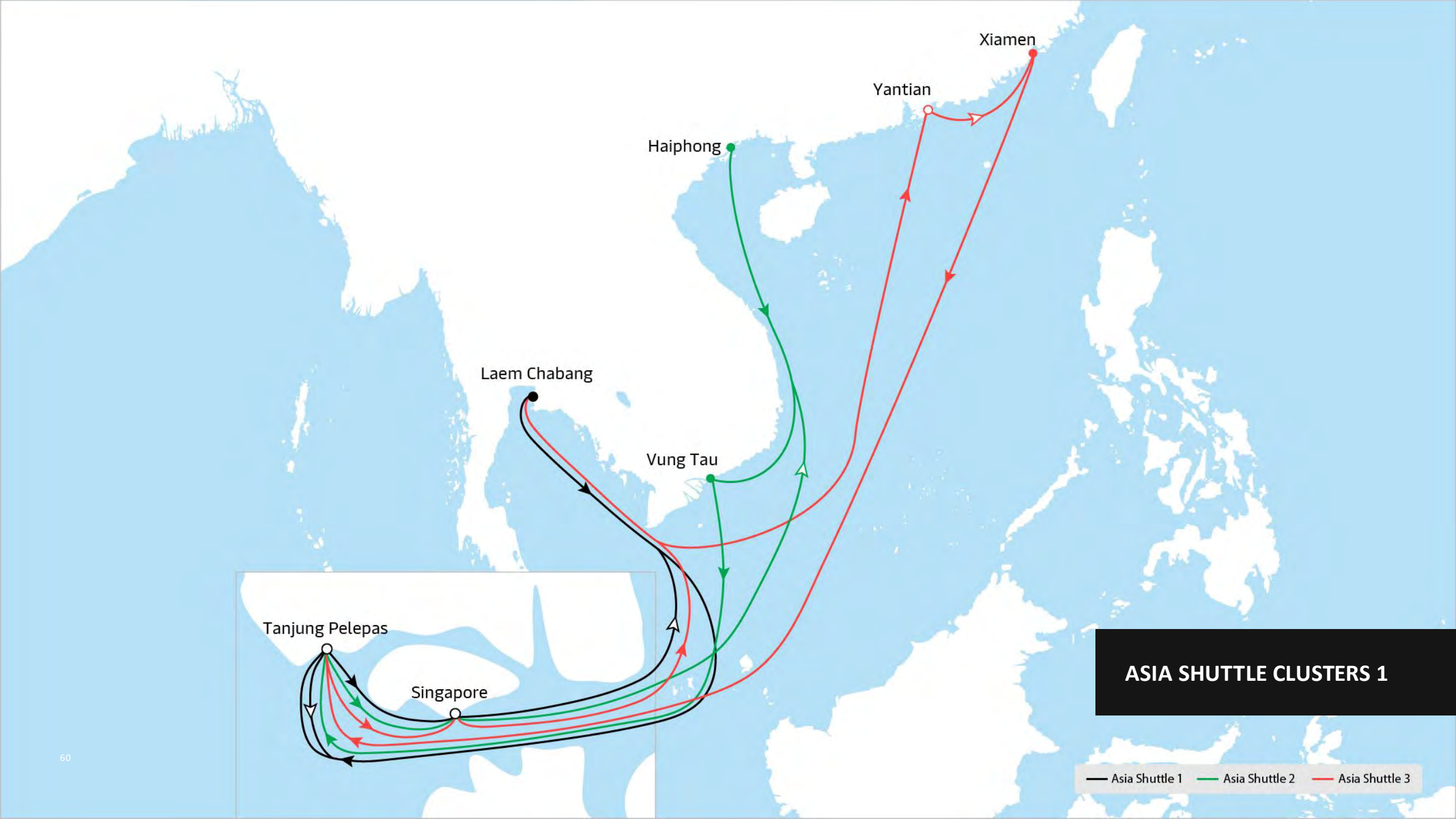

ASIA SHUTTLE CLUSTERS 1

— Asia Shuttle 1 — Asia Shuttle 2 — Asia Shuttle 3

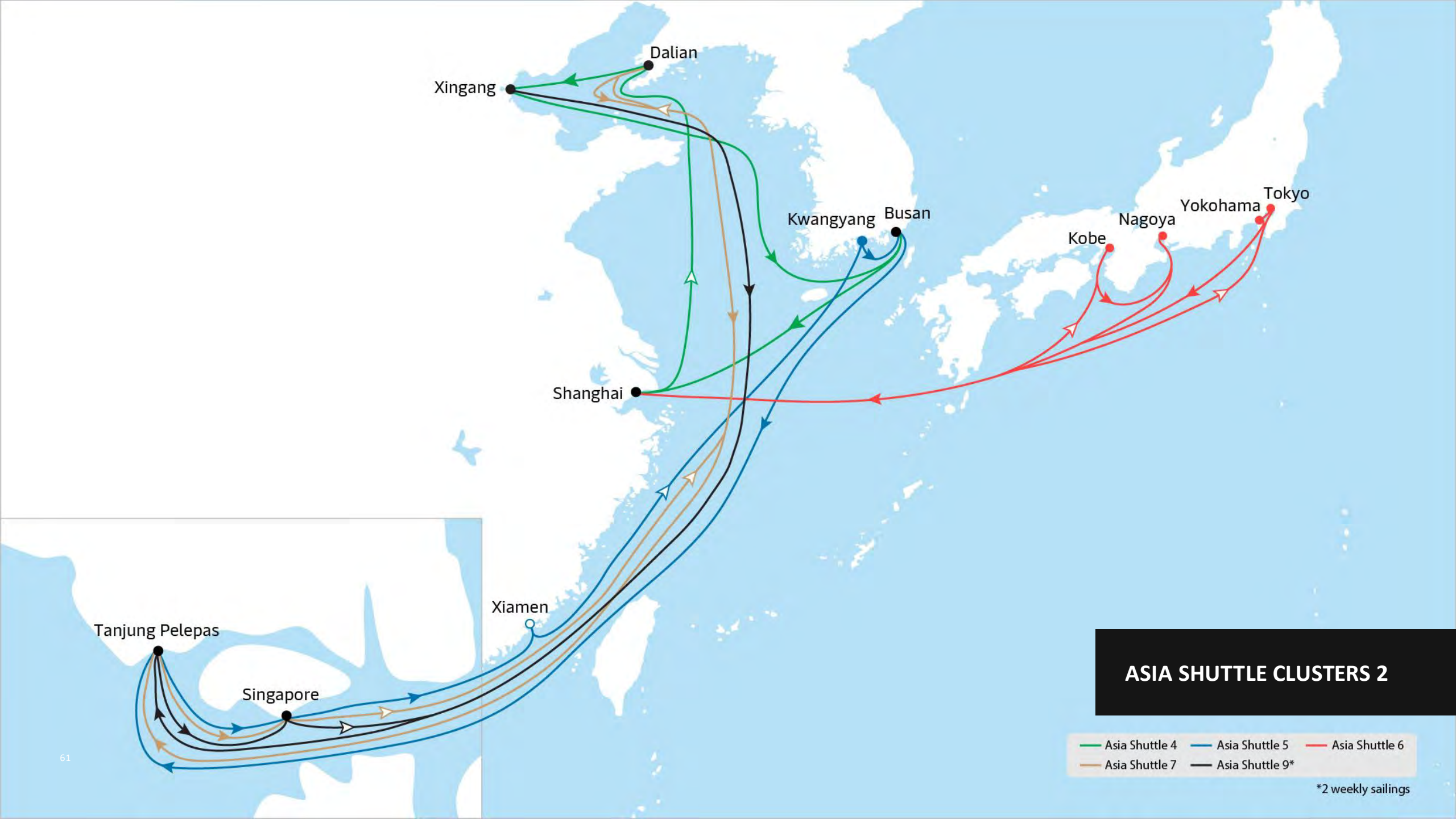

ASIA SHUTTLE CLUSTERS 2

- Asia Shuttle 4
- Asia Shuttle 5
- Asia Shuttle 6
- Asia Shuttle 7
- Asia Shuttle 9*

*2 weekly sailings

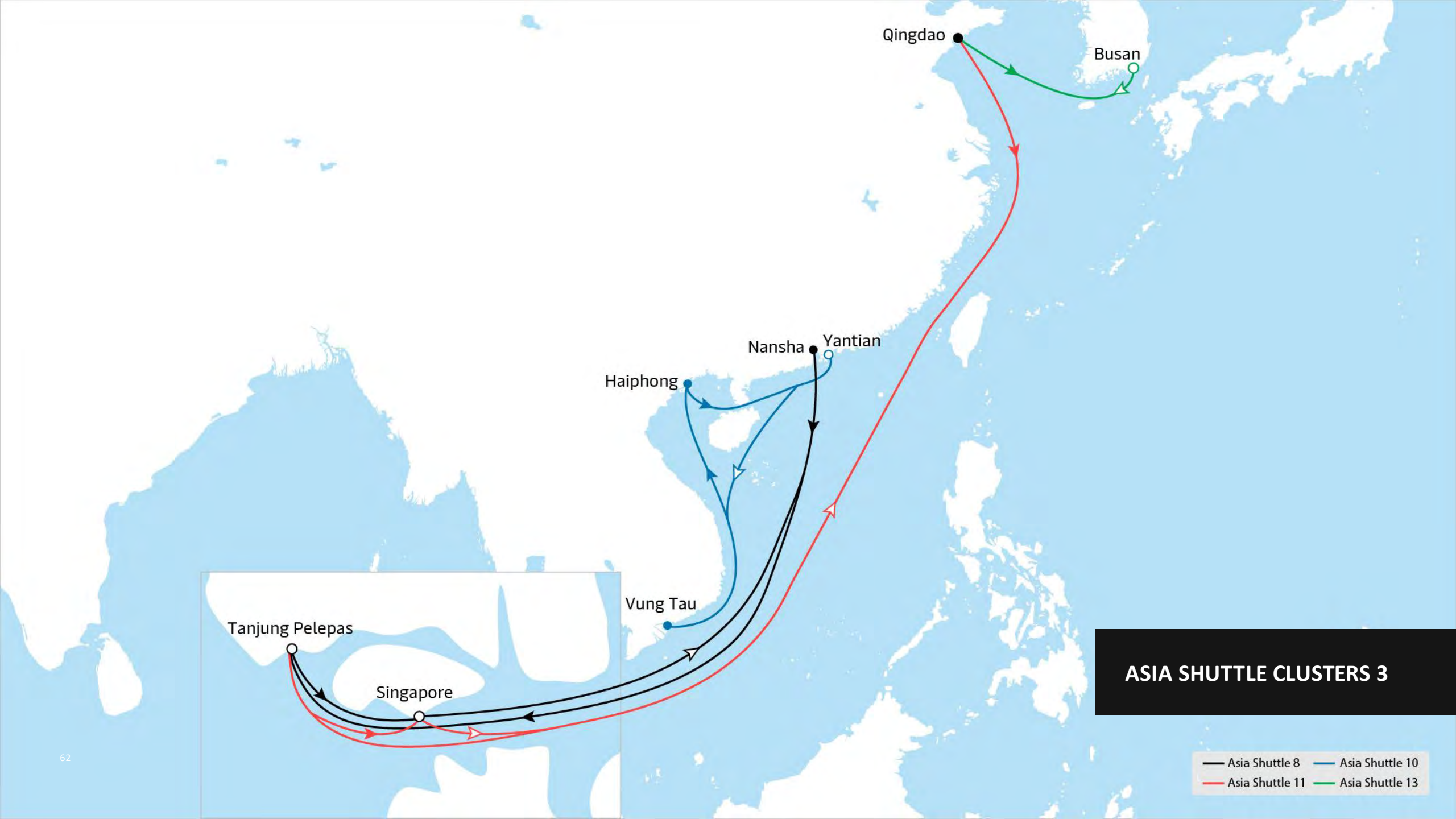

ASIA SHUTTLE CLUSTERS 3

- Asia Shuttle 8
- Asia Shuttle 10
- Asia Shuttle 11
- Asia Shuttle 13

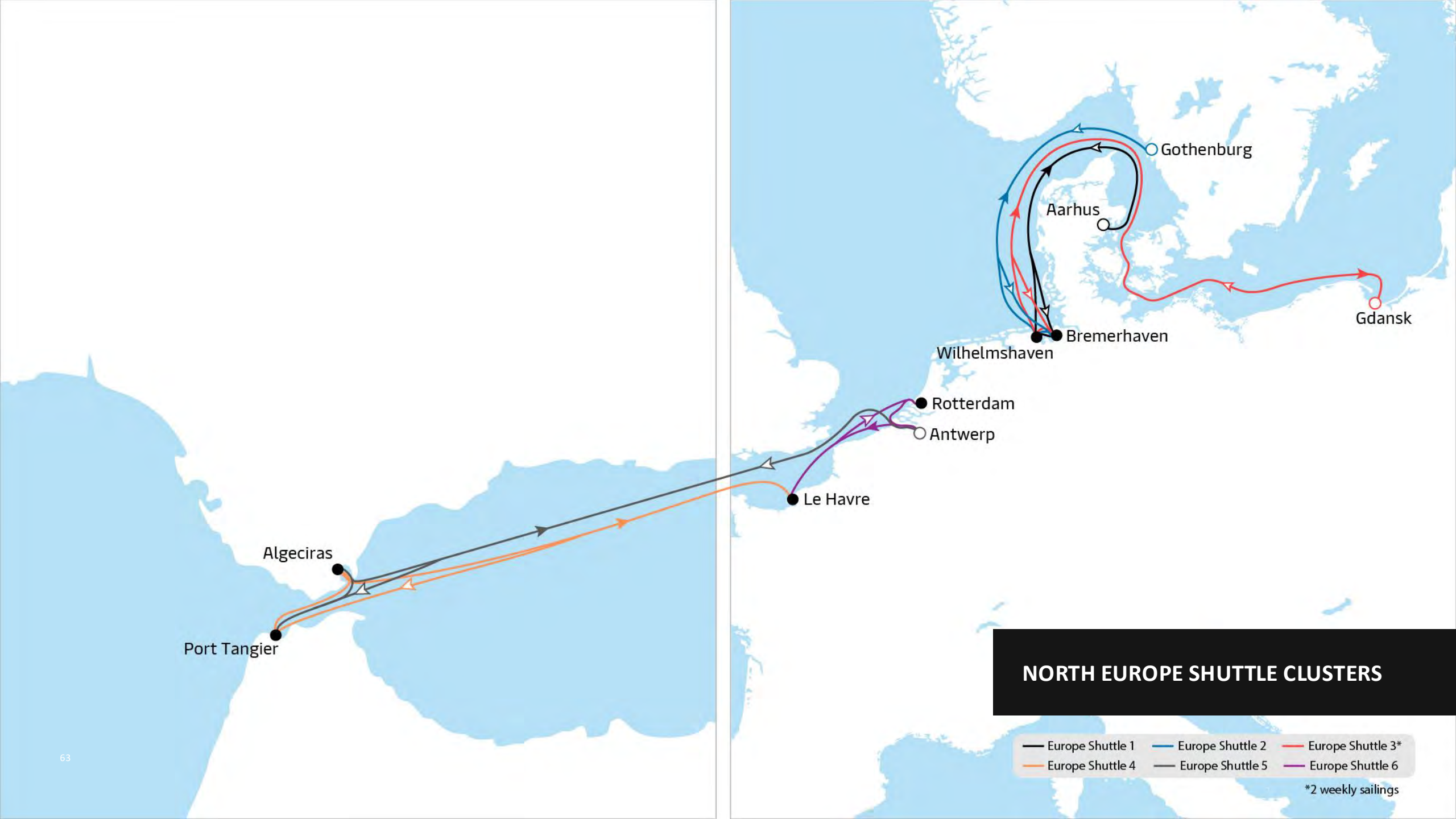

NORTH EUROPE SHUTTLE CLUSTERS

- Europe Shuttle 1 — Europe Shuttle 2 — Europe Shuttle 3*
- Europe Shuttle 4 — Europe Shuttle 5 — Europe Shuttle 6

*2 weekly sailings

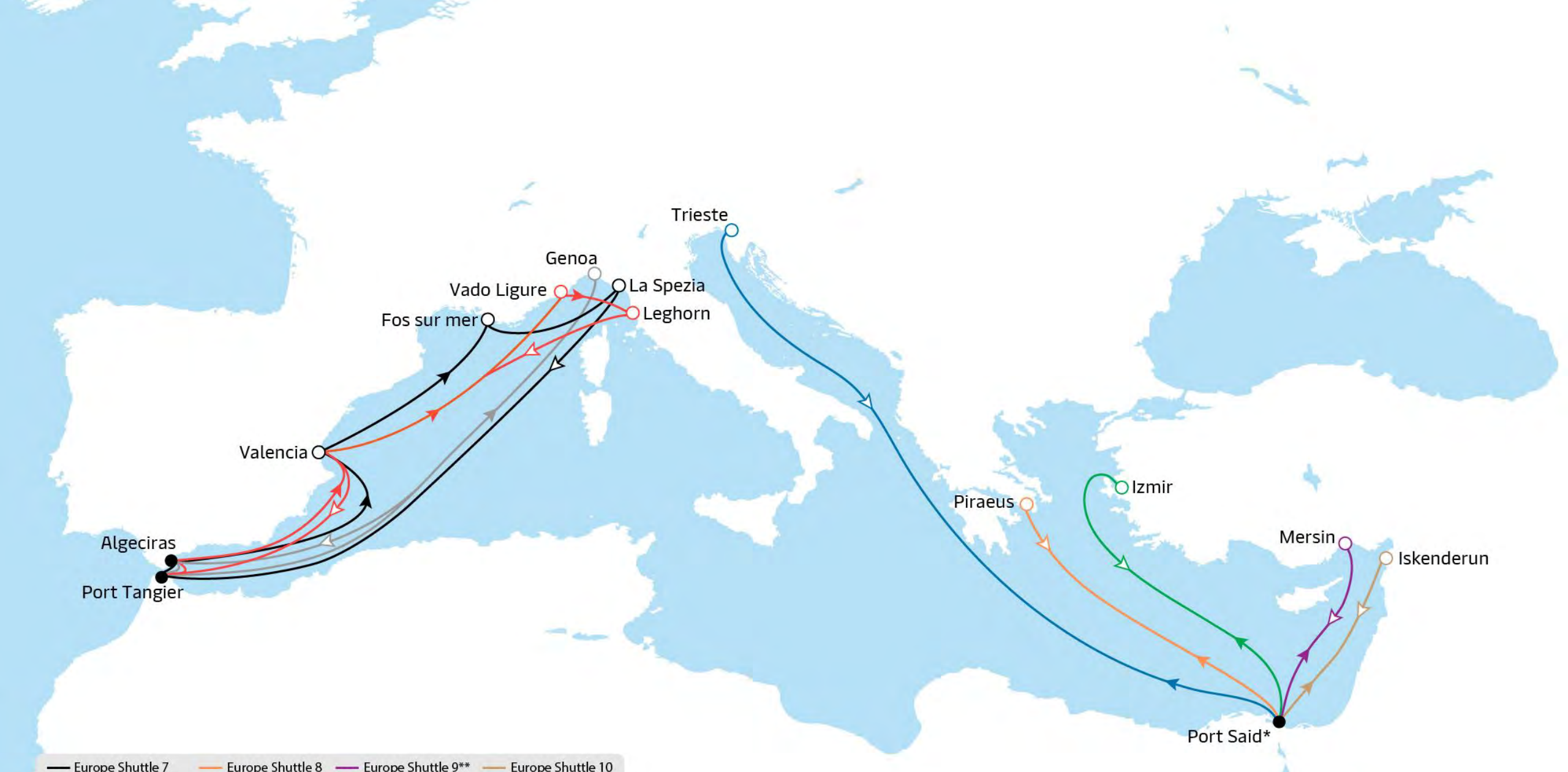

- Europe Shuttle 7
- Europe Shuttle 8
- Europe Shuttle 9**
- Europe Shuttle 10
- Europe Shuttle 11**
- Europe Shuttle 13
- Europe Shuttle 14

*Certain Port Said EB calls will be transferred to Damietta during 2025.

**2 weekly sailings

MEDITERRANEAN SHUTTLE CLUSTERS

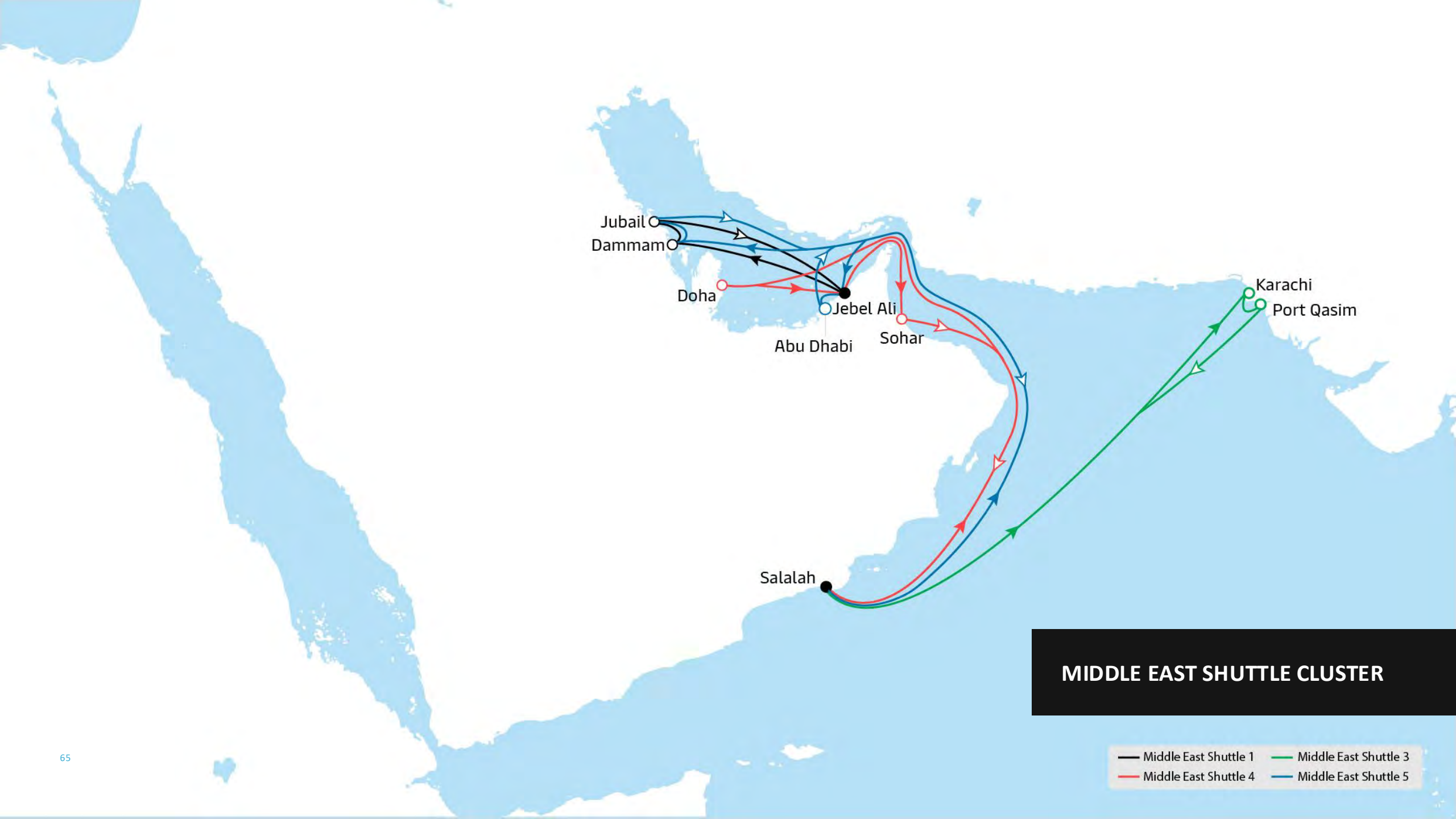

MIDDLE EAST SHUTTLE CLUSTER

- Middle East Shuttle 1
- Middle East Shuttle 3
- Middle East Shuttle 4
- Middle East Shuttle 5



Jacksonville

Miami

Cartagena

GULF OF MEXICO SHUTTLE

— North America Shuttle 1